

CALFIRE

The Fireside Collection

- 2013/14 -

www.calfire.com



Welcome to the 2013/14 CALFIRE FIRESIDE COLLECTION.

CALFIRE is a long established family group of companies with a strong reputation for quality products and service throughout the heating and fireplace industry. Friendly and approachable, CALFIRE prides itself on customer service.

In November 2010 CALFIRE took over the supply and distribution of the exceptional Kingsworthy Foundry range of fireside accessories for log and coal burning fires. As a result CALFIRE now offer the most comprehensive range of quality cast iron firebacks, firebaskets, swansnest baskets, ducksnest baskets, firedogs and reeded panels together with superb quality British Made steel firebaskets and blacksmith produced firedogs. CALFIRE are grateful to Kingsworthy Foundry for allowing them to use their logo in this years catalogue to show continuity of supply.

CALFIRE are unique within the fireplace and heating industry with their extensive product related ranges. In addition to offering a most comprehensive selection of Fireside Accessories they are also:

- The official UK distributor for StoveBright™ High-Temperature Paint, selling the product in aerosol and touch-up forms to retailers as well as in bulk liquid form to many of the leading UK traditional Woodburning Stove Manufacturers.
- The official UK distributor for Ecofans®. These products sit on the top of woodburning stoves and assist in distributing the stoves heat without using mains or battery power. Improved warm air circulation results in greater comfort and less fuel consumption. Ecofans® are a great favourite with the countries many Narrow Boat enthusiasts. Visit the UK specific Ecofan® website at www.ecofan.co.uk for full information.
- A major supplier of Replacement Stove Glass offering Ceramic Glass panels, Borofloat Strips as well as Mica. All popular sizes are available 'off the shelf' with in house facilities available for cutting your special requirements.

INDEX

ALL NIGHT BURNERS	63
ASH CARRIERS	64
BELLOWS	14
COWLS & BIRD/RAIN GUARDS	80 - 81
CASTINGS	44 - 64
* FORMER KWF OPEN FIRE RANGE	13,44-57
CERAMICS	82
CLEANING PRODUCTS	85 - 86
COAL BUCKETS	34 - 37
COMPANION SETS	3 - 13
ECOFANS®	72 - 75
FENDERS	68 - 71
FIRE CEMENT & COMPOUNDS	82
FIRE GRATES & ASH PANS	63
FIRE SCREENS	19 - 33
FIRE TRIMS	67
FIRESIDE ACCESSORIES	14 - 18
FRETS - GAS & ELECTRIC	65 - 67
FRETS - SOLID FUEL	64
GAS BURNERS	61
HEARTH TIDIES	15
LOG BASKETS, CARRIERS & RACKS	38 - 43
SERVICE & INSTALLATION	83 - 84
STOVBRIGHT HT PAINT	76
STOVE GLASS & MICA	77
MEET THE TEAM	IBC



CALFIRE supply to trade accounts all over the Country, however members of the public are welcome to browse through this catalogue or visit the companies website at www.calfire.com. Contact with the company can be made through an email facility where product information or details of local stockists can be ascertained.

Alternatively contact your stockist or telephone our friendly staff on **01691 772922**

Please note that specified finishes such as Brass, Antique, Chrome, Satin Nickel, Pewter, Copper, Copper Bronze & Steel relate to the colour only and not the material.

 Throughout pages 3-71 of this catalogue, British Manufactured items are clearly indicated with the union flag for your information.

Due to studio lighting and printing inks, the colours shown in this catalogue may differ slightly from those of the actual products. Any dimensions or weights given are approximate and should only be used as a guide. Key to dimensions: H=Height; D=Depth; W=Width; L=Length. Calfire's aim is one of constant improvement and the company reserves the right to change specifications without written notice. Reproduction of the photographs in this catalogue is prohibited without the prior written permission from Calfire Ltd.

Loop Top Height 630 (25")

*Specified finishes
relate to colour only
and not material.*



27013
Black & Brass



27077
Black & Antique



27006
All Antique



27023
All Black



27008
Black & Chrome



27127
All Satin
Nickel



27101
Black & Satin Nickel



Ball Top

Height 590 (23")



27112
Black & Satin Nickel

27128
All Satin Nickel

27111
Black & Brass

27113
Black & Antique

27094
All Black

Specified finishes relate to colour only and not material.

Traditional Top - 3 Legged Base

Height 600 (24")



27088
All Black

4

27096
All Satin Nickel

27107
Black & Brass

Traditional Top - Round Base

Height 406 (16")



27114
Black & Brass



27116
Black & Antique



27115
Black & Satin Nickel



27095
All Black



Specified finishes relate to colour only and not material.

Traditional Top - Round Base

Height 570 (22.5")



27110
Black & Brass



27109
Black & Satin Nickel



5 27108
All Black



Acorn - Height 540 (21")



27017
All Black

27117
Black &
Satin Nickel

27031
Black & Brass

27073
Black & Chrome

27030
Black & Antique

Specified finishes relate to colour only and not material.

Spiral - Height 610 (24")

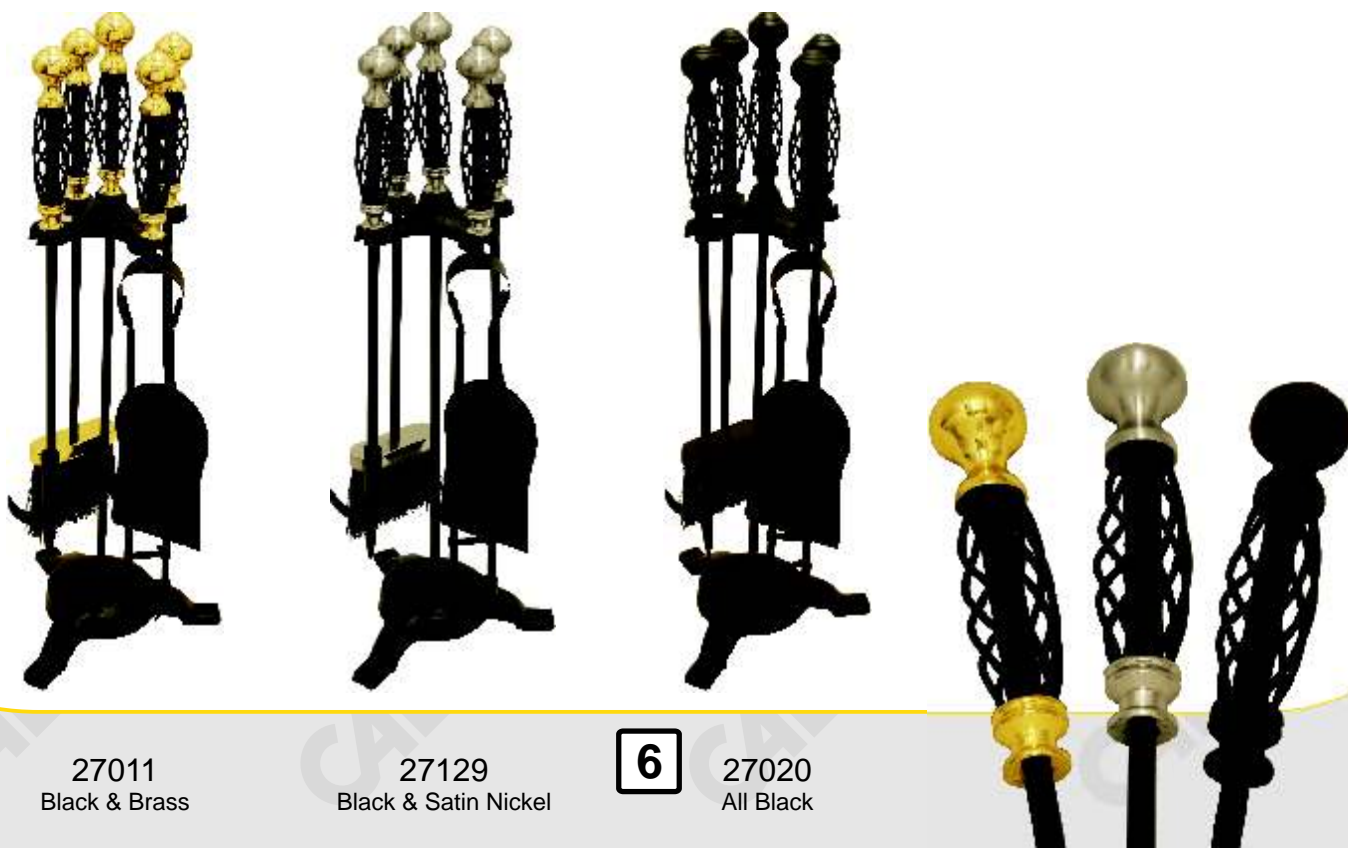

27011
Black & Brass

27129
Black & Satin Nickel

6

27020
All Black

*Specified finishes
relate to colour only
and not material.*

Cage

Height 685 (27")



27104
All Black



Gallery

Height 590
(23")



27007
Black & Chrome



27102
Black &
Satin Nickel



27005
Black & Antique



27019
All Black



27010
Black & Brass

Basket - Height 410 (16")

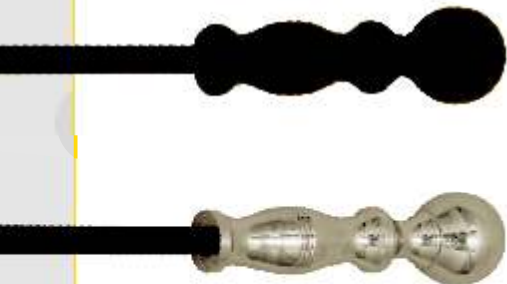

27083
Black & Chrome

27057
All Black

Specified finishes relate to colour only and not material.

Pyramid - Height 660 (26")



27133
Satin Nickel

27132
All Black

Hordley - Height 605 (24")

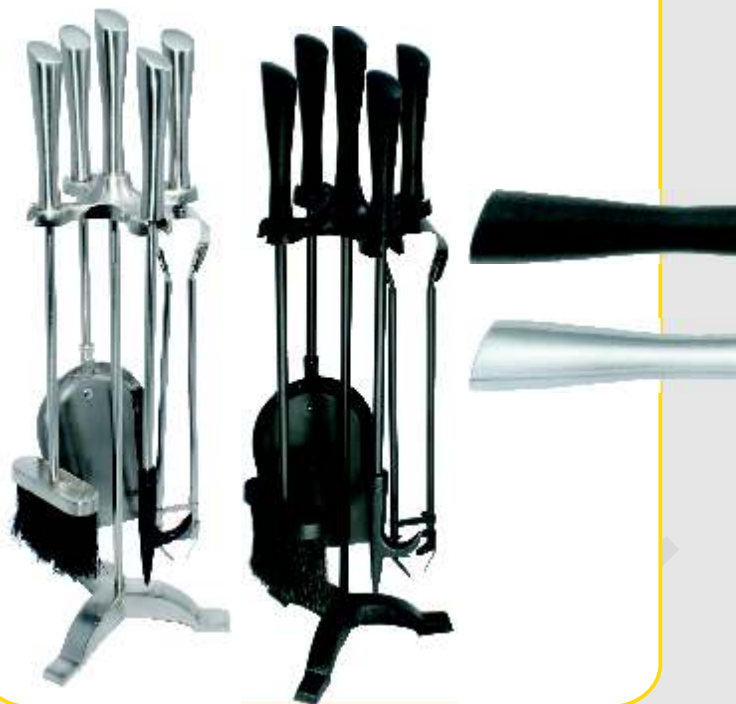

27131
Satin Nickel

27130
All Black

Duchess

Heights 400 & 480 (16 & 19")



27085 16"
27086 19"
Black & Solid Brass



27123 16"
27124 19"
Black & Antique Brass EP



27118 16"
27119 19"
Black & Pewter



27043 16"
27045 19"
All Black

Specified finishes relate to colour only and not material.

Regency

Rope Twist

Open Twist

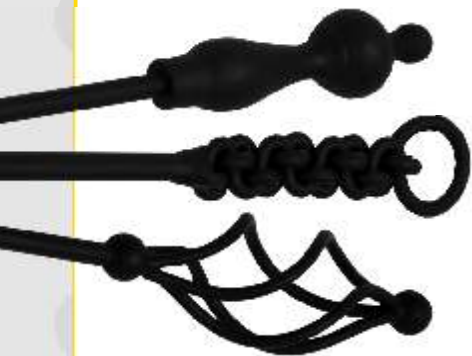

Specified finishes relate to colour only and not material.



27078
All Black
H 470 (18")



27041
All Black
H 650 (26")

Supplied with Log & Coal Tongs with Poker in centre.



27048
All Black
H 515 (20")

Worthen



27037
All Black
H 640 (25")

Weston



27141
All Black
H 710 (28")

Wood
Stove



27142
All Black
H 535 (21")

Basic



27138
All Black
H 700 (27.5")

This Basic Fireset is part of a set of 'basic' products that are available. Also see the 'basic' firescreen on page 22 and the 'basic' log carrier on page 40.

Specified finishes relate to colour only and not material.

Vintage Craftsman



27139
All Black
H 700 (27.5")

Crook



27140
All Black
H 760 (30")

Twist



27122
Silver Black
H 675 (26.5")

Knight



27120
Silver Black
H 740 (29")

Rushton

Petton

Horton

Tilley

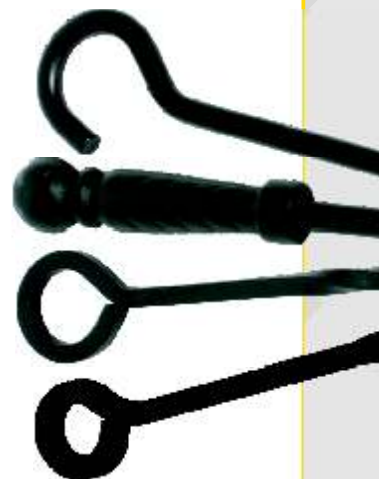

27054
All Black
H 635 (25")

27137
All Black
H 605 (24")

27136
All Black
H 685 (27")

27135
All Black
H 665 (26")

Specified finishes relate to colour only and not material.

Forged

Pony

Cast



27134
All Black
H 685 (27")

27125
All Black
H 520 (21")

27018
All Black
H 520 (20.5")

Ellie



27126
Black & Frosted Glass
H 780 (31")

*Modern
Ball*



27064
All Black
H 465 (18")

*Modern
Round*



27092
All Black
H 580 (23")

Ercall



27097
All Black
H 610 (24")



Specified finishes relate to colour only and not material.

Fleur-de-lys

H 520 (20.5")



27106
Brushed Steel

27105
All Black

12

*Fire Irons & Dogs
Victorian*



27091
All Black. L Irons 700 (28") H Dogs 230 (9")
SET OF 4 FIRE IRONS & 1 PAIR OF DOGS.



CALFIRE are proud to announce that we acquired the supply of the highly acclaimed range of quality castings from Kingsworthy Foundry in the autumn of 2010.

The Premier quality castings, British Made fire baskets, fire dogs etc from the Kingsworthy range are detailed within pages 44-57 of this catalogue. These ancillary items however have been integrated within our existing ranges.

Hearth Accessories:

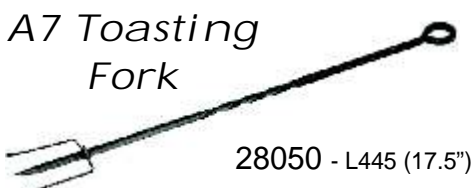

Ring Top



26002 - H 560 (22")
26003 - H 660 (26")
26004 - H 760 (29")
All Black

Cage

26005 - H 595 (23.5")
26006 - H 725 (28.5")
All Black

Regent

26001
All Black
H 675 (26.5")



Bellows



Made from Sheesham Wood, Leather & Solid Brass.
Sheesham is a heavy hardwood with a rich chestnut colour.

29069

Carved Hardwood Bellows
Length 470 (18.5")

29080

Plain Hardwood Bellows
Length 355 (14")

29015

Fleur-de-lys Hardwood Bellows
Length 470 (18.5")

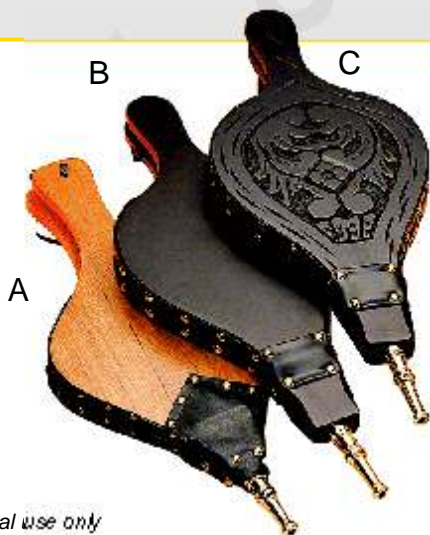

Ornamental use only

A - 29013
Oak
Length 480 (19")

B - 29017
Wood
Length 510 (20")

C - 29014
Carved
Length 510 (20")

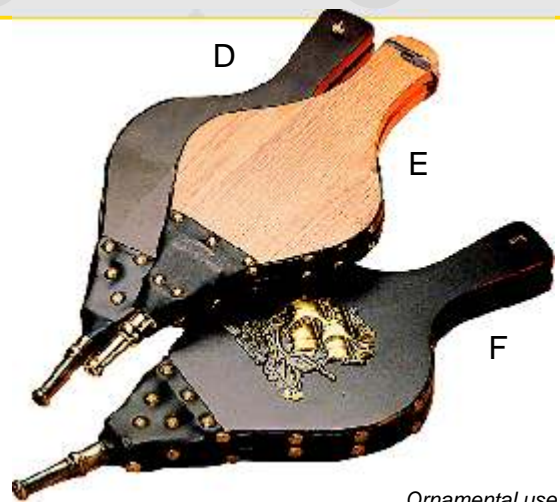

Ornamental use only

D - 29016
Wood
Length 420 (16")

E - 29012
Oak
Length 380 (15")

F - 29011
Ship
Length 430 (17")

Hearth Tidies



Length 340 (13")
29019
Black
Large Ball

*Specified finishes
relate to colour only
and not material.*



Length 380 (15")

29066
Black Traditional

29075
Black & Brass



Length 300 (12")

29003
Black
Cast

29064
Black &
Brass Cast

29081
Black & Satin
Nickel Cast

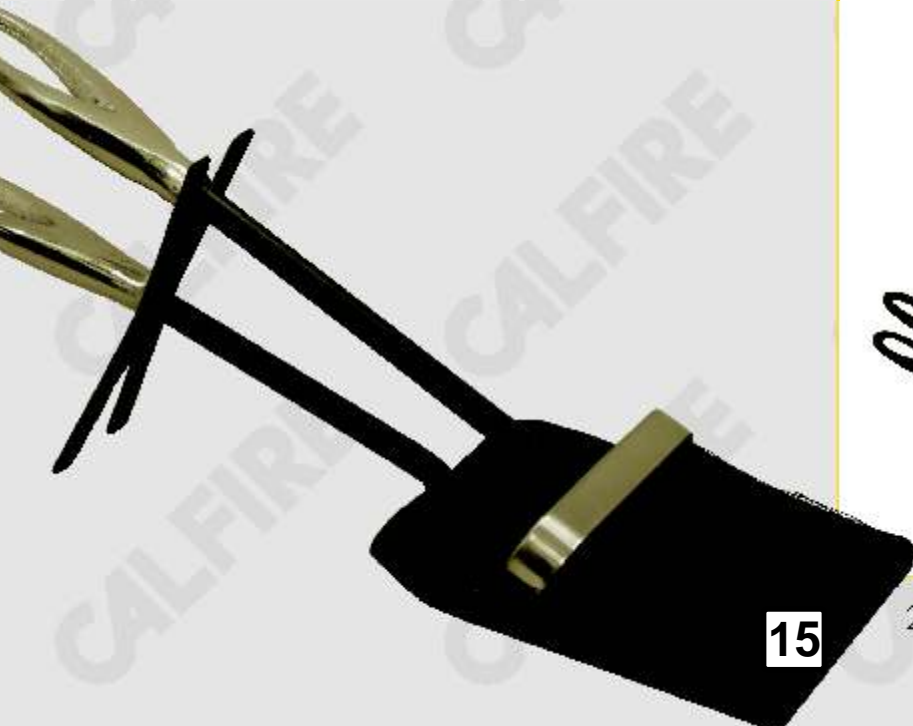

Length 380 (15")

29071
Black
Loop

29072
Black &
Brass Loop

29082
Black & Satin
Nickel Loop

Match Holders & Matches



29055
All Black

Holder H200 (8")
[Excluding Matches]

29004
Brass & Copper

29005
Long Matches
L280 (11")

90 matches per box

Coal & Log Tongs

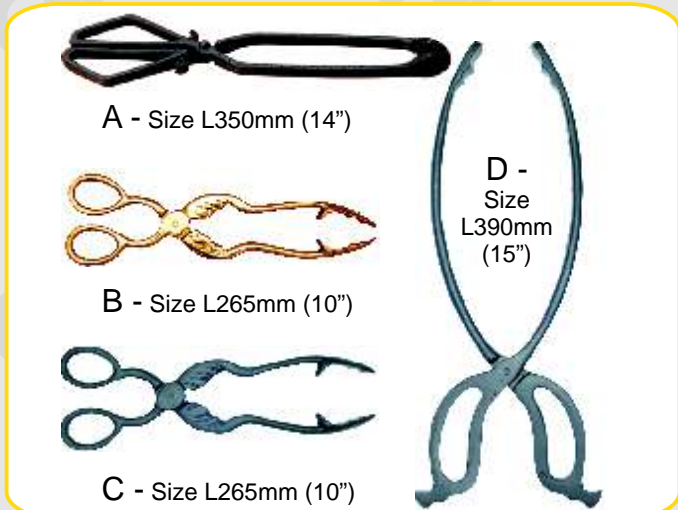

A - Size L350mm (14")



B - Size L265mm (10")



C - Size L265mm (10")



D -
Size
L390mm
(15")

A - 29008 Black Cast
B - 29060 Solid Brass Coal Tongs
C - 29062 Black Coal Tongs
D - 29063 Black Log Tongs

Shovels



E. 28040 6" Steel Shovel
F. 28039 5" Steel Shovel
G. 28038 4" Steel Shovel

H. 28042 9x7" Shovel
I. 28043 10x8" Shovel

28044
10x8" Galv Shovel

Brush Refills



28031 Round Brush (British)

29070 Round Brush (Chinese)

29046 Round Brush (Indian)

29056 Small Round Brush (Indian 16" Companion Sets)

29009 Oblong Brush (Chinese)

29047 Oblong Brush (Indian)

29079 Straw Brush (Chinese)



29050 Small Shovel Length 305 (12")

29048 Large Shovel Length 350 (14")

Individual Tools Ring Top Tools - Length 450 (18")

Hangers

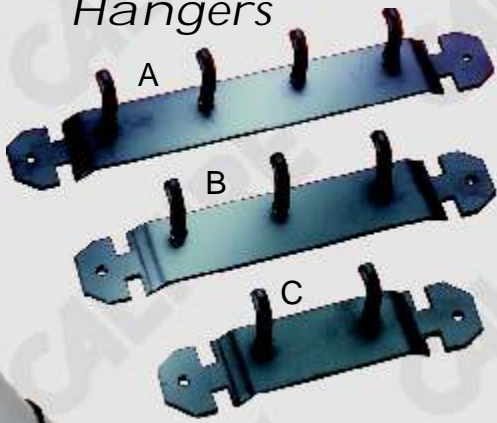

- | | | |
|-------------------------|------------------------|------------------------|
| A | B | C |
| 29054 | 29053 | 29052 |
| 4 Position
L265(10") | 3 Position
L220(9") | 2 Position
L160(6") |

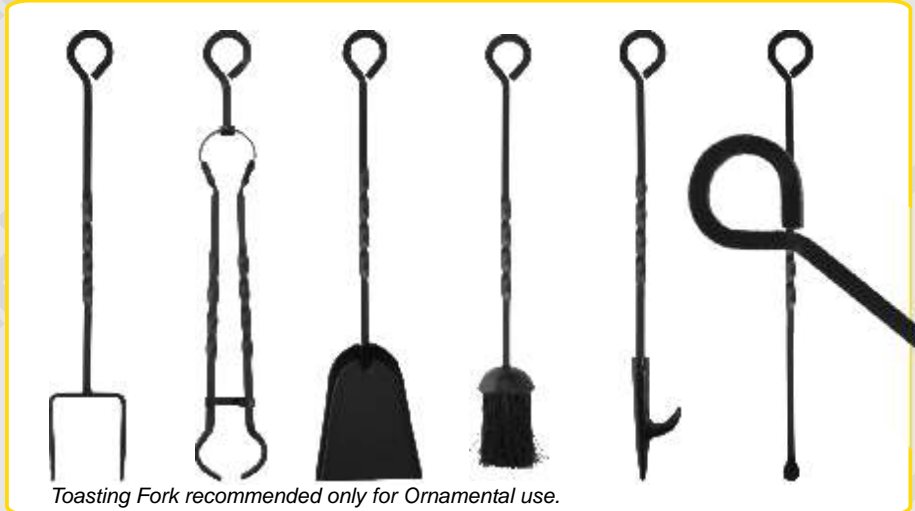

Toasting Fork recommended only for Ornamental use.

- | | | | | | |
|------------------|---------------|--------|-------|---------------|-------|
| 29083 | 29084 | 29085 | 29086 | 29087 | 29088 |
| Toasting
Fork | Coal
Tongs | Shovel | Brush | Log
Roller | Poker |

Loop Top Tools - Length 450 (18")



Toasting Fork and Roaster recommended only for Ornamental use.

- | | | | | | | | |
|------------------|---------------|--------------|--------|-------|---------------|-------|---------|
| 29030 | 29031 | 29032 | 29033 | 29034 | 29035 | 29036 | 29037 |
| Toasting
Fork | Coal
Tongs | Log
Tongs | Shovel | Brush | Log
Roller | Poker | Roaster |

Rope Twist Tools - Length 450 (18")



Toasting Fork and Roaster recommended only for Ornamental use.

- | | | | | | | | | |
|------------------|---------------|--------------|--------|-----------|-------|---------------|-------|---------|
| 29038 | 29039 | 29040 | 29041 | 17 | 29042 | 29043 | 29044 | 29045 |
| Toasting
Fork | Coal
Tongs | Log
Tongs | Shovel | | Brush | Log
Roller | Poker | Roaster |

Pokers & Poker Sets

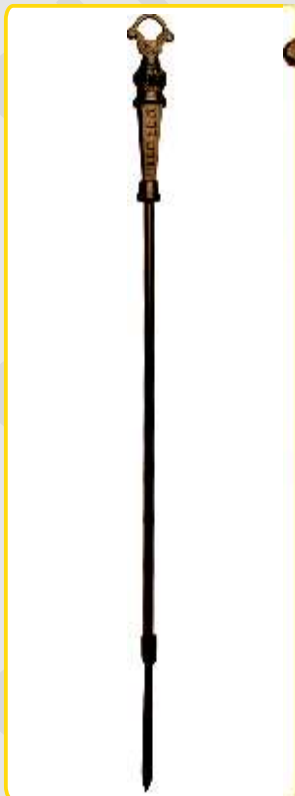

29065
Black Victorian
Poker
L 700 (28")



29021
Black Poker & Stand
H 580 (23")



Poker & Ash Scraper Set. L610 (24")

29067
Black



Sets of 5 various Pokers. L760 (30")

29068
Set of 5 Pokers - Black & Antique



Sets of 5 various Pokers. L760 (30")

4 Fold



Chrome

21044
H640 Panels 200
(25x8")



Satin Nickel



Black



- 21075 - H540 Panels200 (21x8")
- 21047 - H640 Panels200 (25x8")
- 21076 - H710 Panels315 (28x12")
- 21077 - H820 Panels315 (32x12")

- 21027 - H540 Panels200 (21x8")
- 21028 - H640 Panels200 (25x8")
- 21029 - H710 Panels315 (28x12")
- 21026 - H820 Panels315 (32x12")

**Specified finishes
relate to colour only
and not material.**

Brass



Antique



- SNA - H540 Panels200 (21x8")
- 21014 - H640 Panels200 (25x8")
- 21012 - H710 Panels315 (28x12")
- 21011 - H820 Panels315 (32x12")

- 21023 - H540 Panels200 (21x8")
- 21022 - H640 Panels200 (25x8")
- 21020 - H710 Panels315 (28x12")
- 21019 - H820 Panels315 (32x12")

3 Fold

Chrome
21043
H670 W430 Wings210
(26x17x8")



CALFIRE
The Fireside Collection

Black

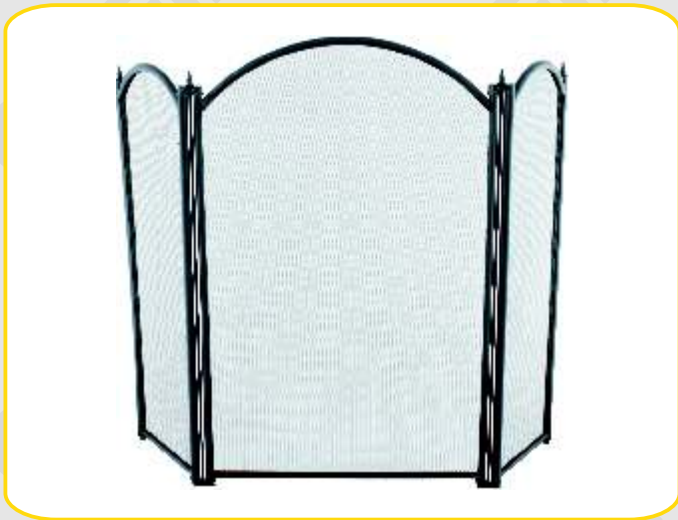

21030 - H670 W430 Wings210 (26x17x8")
21025 - H750 W610 Wings280 (29x24x11")

Satin Nickel



21048 - H670 W430 Wings210 (26x17x8")
21078 - H750 W610 Wings280 (29x24x11")

*Specified finishes
relate to colour only
and not material.*

Antique



21024 - H670 W430 Wings210 (26x17x8")
21021 - H750 W610 Wings280 (29x24x11")

Brass



21015 - H670 W430 Wings210 (26x17x8")
21010 - H750 W610 Wings280 (29x24x11")

3 Fold

Black
Plain &
Decorative
Wrought

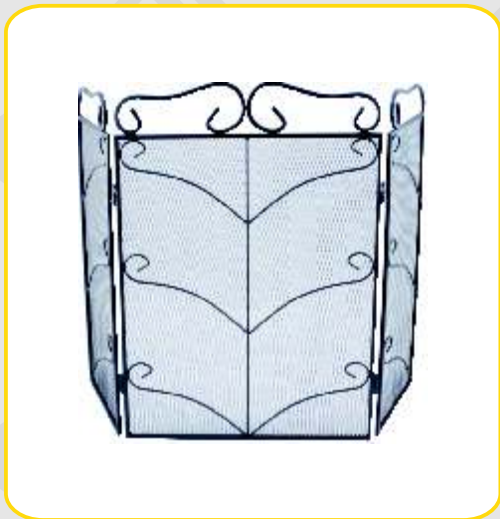

Black 21049
H580 W450 Wings210
(23x18x8")

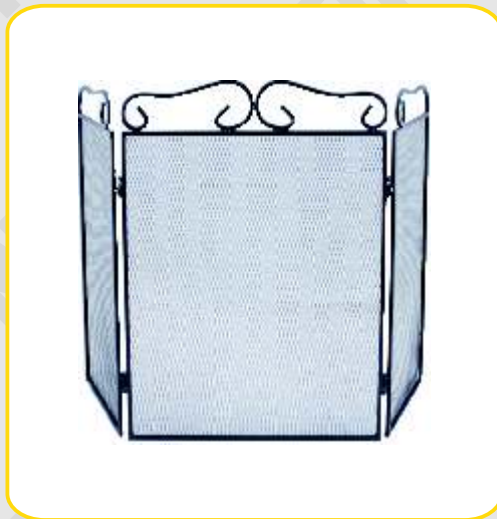

Black 21050
H580 W450 Wings210
(23x18x8")



Black 21059
H710 W450 Wings210
(28x18x8")



Black 21060
H710 W450 Wings210
(28x18x8")

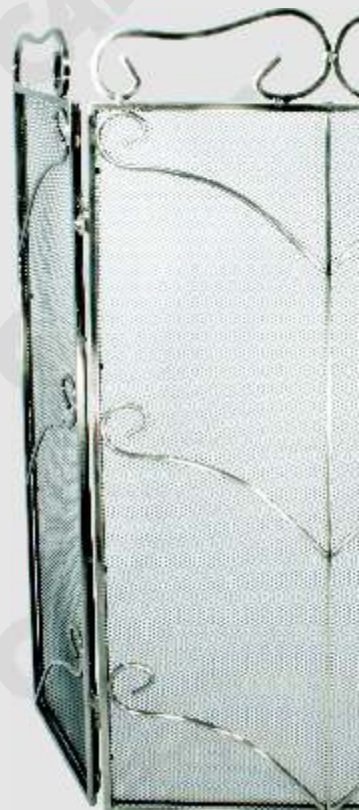

Steel Plain & Decorative Wrought



Steel 21061
H580 W450 Wings210
(23x18x8")

Steel 21062
H580 W450 Wings210
(23x18x8")

Steel 21088
H710 W450 Wings210
(28x18x8")

Steel 21089
H710 W450 Wings210
(28x18x8")

3 Fold

CALFIRE
The Fireside Collection



The Basic Screen featured below is part of a set of 'basic' products that are available. Also see the 'basic' fire set on page 10 and the 'basic' log carrier on page 40.

Arched

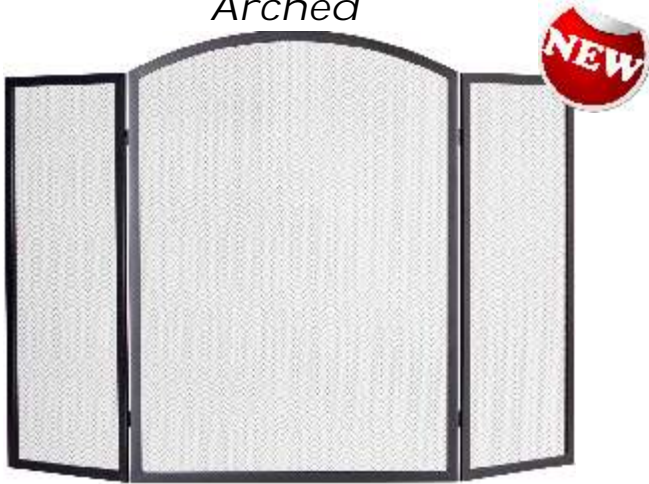

Black 21098 H635 W530 Wings230 (25x21x9")
Black 21099 H710 W610 Wings280 (28x24x11")

Basic

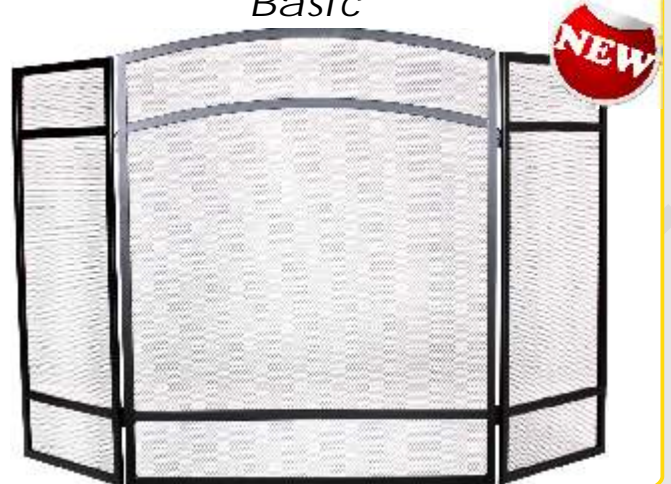

Black 21096 H635 W530 Wings230 (25x21x9")
Black 21097 H710 W610 Wings280 (28x24x11")

Diamond

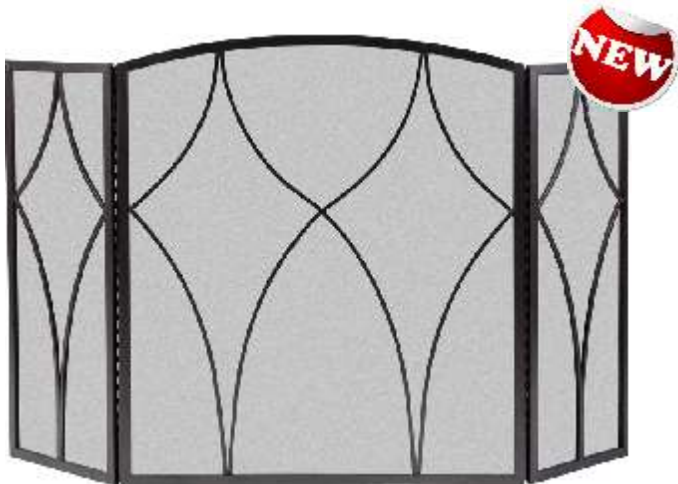

Black 21094
H710 W610 Wings280
(28x24x11")

Medallion

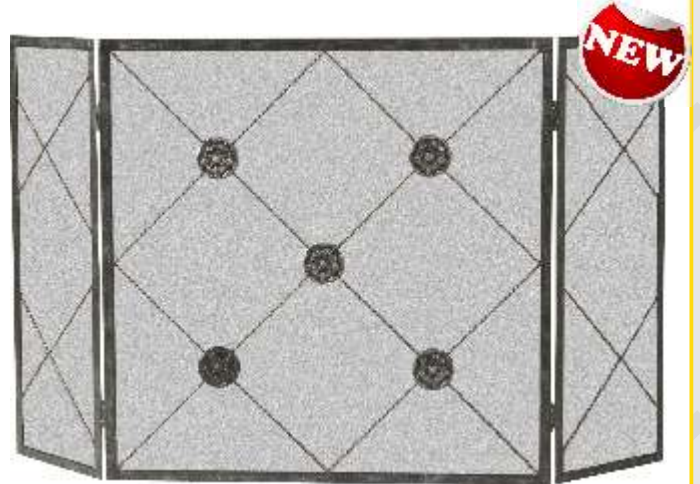

Black 21095
H710 W610 Wings280
(28x24x11")



Single Panel



Plain Flat



Black 21092 H610 W660 (24x26")
Black 21093 H710 W760 (28x30")

Narrow Curved



Black 21090 H610 W660 D70 (24x26x2.75")
Black 21091 H710 W760 D95 (28x30x3.75")

Curved



Black 21083
H710 W860 D245
(28x34x9.5")





The Noble Collection

Flat



Alum Trim

20057
H610 W610
(24x24")



Brass Trim

20056
H610 W610
(24x24")



Black

20055 H610 W610 (24x24")
20079 H610 W760 (24x30")
20080 H685 W760 (27x30")
20081 H760 W915 (30x36")

Fixing kit 21500 available separately; see page 28 for details.

Arched Flat



Alum Trim

20021
H610 W610
(24x24")



Brass Trim

20000
H610 W610
(24x24")



Black

20011 H610 W610 (24x24")
20082 H610 W760 (24x30")
20083 H685 W760 (27x30")
20084 H760 W915 (30x36")

Fixing kit 21500 available separately; see page 28 for details.

All NOBLE firescreens can be 'made to measure' with your height, width and, if relevant, depth dimensions. Call for details.
 Heights given for firescreens exclude handles.

Flat Fan



Fixing kit 21500 available separately; see page 28 for details.

Black **20069**
H620 W925
(24.5x36.5")

Flat Sided Bowed



Fixing kit 21500 available separately; see page 28 for details.

Black **20068**
H610 W795 D185
(24x31x7.25")

ALL BRITISH
 MADE IN THE
 UK
 ON THIS
 PAGE



The Noble Collection

Wedge

Alum Trim
20026
H610 W585 D150
(24x23x6")

Brass Trim
20005
H610 W585 D150
(24x23x6")

Black
20016
H610 W585 D150
(24x23x6")

Fixing kit 21500 available separately; see page 28 for details.

Curved

Alum Trim
20025
H610 W585 D75
(24x23x3")

Brass Trim
20004
H610 W585 D75
(24x23x3")

Black
20015
H610 W585 D75
(24x23x3")

Fixing kit 21500 available separately; see page 28 for details.

All NOBLE firescreens can be 'made to measure' with your height, width and, if relevant, depth dimensions. Call for details.
Heights given for firescreens exclude handles.

Curved Delux

Fixing kit 21500 available separately; see page 28 for details.

Brass Trim 20010
H610 W585 D75
(24x23x3")

Alum Trim 20031
H610 W585 D75
(24x23x3")





The Noble Collection

Box Closed



Alum Trim 20028 H610 W640 D230 (24x25x9")
Brass Trim 20007 H610 W640 D230 (24x25x9")
Black 20018 H610 W640 D230 (24x25x9")

Fixing kit 21500 available separately; see page 28 for details.

Box Open



Alum Trim 20027 H610 W640 D230 (24x25x9")
Brass Trim 20006 H610 W640 D230 (24x25x9")
Black 20017 H610 W640 D230 (24x25x9")

Fixing kit 21500 available separately; see page 28 for details.

All NOBLE firescreens can be 'made to measure' with your height, width and, if relevant, depth dimensions. Call for details.
Heights given for firescreens exclude handles.

Sloping Box - H690 W610 D205 (27x24x8")



Fixing kit 21500 available separately; see page 28 for details.

Black 20061

Brass Trim 20062

Alum Trim 20063





The Noble Collection

Double Rail Box Open



Black

20092

H650 W660 D175
(25.5x26x7")



Steel Clear
Lacquer Finish

20093

H650 W660 D175
(25.5x26x7")

Fixing kit 21500 available separately; see page 28 for details.

Double Rail Fender Guard

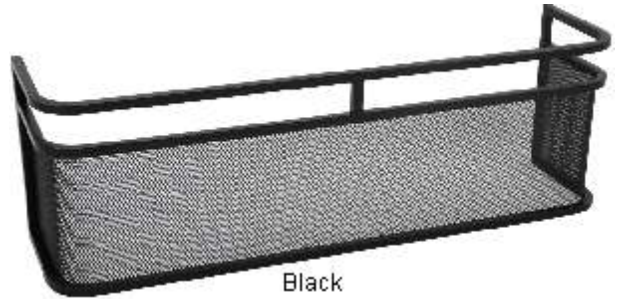

Black

20094

H200 W610 D150
(8x24x6")



Steel Clear
Lacquer Finish

20095

H200 W610 D150
(8x24x6")

Fixing kit 21500 available separately; see page 28 for details.

All NOBLE firescreens can be 'made to measure' with your height, width and, if relevant, depth dimensions. Call for details.
Heights given for firescreens exclude handles.

Arched Box



Fixing kit 21500 available separately; see page 28 for details.

Black 20067
H715 W585 D155
(28x23x6")

Bent Box

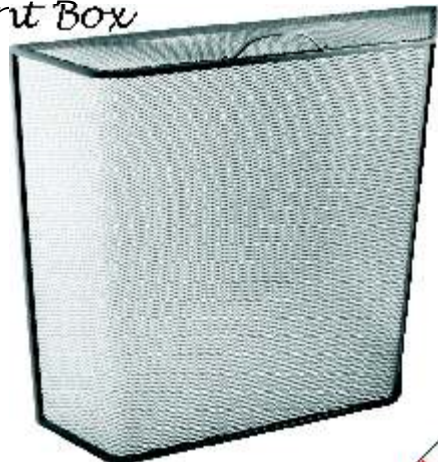

Fixing kit 21500 available separately;
see page 28 for details.

Black 20090
H560 W635 D155 (22x25x6")
Black 20078
H610 W660 D155 (24x26x6")
Black 20091
H760 W760 D155 (30x30x6")



The Noble Collection

Winged

Alum Trim

20030
H610 W610 D200
(24x24x8")

Brass Trim

20009
H610 W610 D200
(24x24x8")

Black

20085
H585 W455 D200 (23x18x8")
20020
H610 W610 D200 (24x24x8")
20086
H685 W760 D200 (27x30x8")
20087
H760 W915 D200 (30x36x8")

Fixing kit 21500 available separately; see page 28 for details.

Bent

Alum Trim

20023
H610 W660 D155
(24x26x6")

Brass Trim

20002
H610 W660 D155
(24x26x6")

Black

20088
H560 W635 D155 (22x25x6")
20013
H610 W660 D155 (24x26x6")
20089
H760 W760 D155 (30x30x6")

Fixing kit 21500 available separately; see page 28 for details.

All NOBLE firescreens can be 'made to measure' with your height, width and, if relevant, depth dimensions. Call for details.
Heights given for firescreens exclude handles.

Arched Bent



Fixing kit 21500 available separately; see page 28 for details.

Black 20074
H660 W660 D130
(26x26x5")

Noble Screen Fixing Kit



Kit comprises:
2 brackets (left and right hand), 2 fixing bolts & nuts,
2 wall brackets with adhesive pads, 2 wall brackets for drilling,
4 fixing screws & wall plugs.

Suitable for Noble Screens as shown

21500





The Noble Collection

All NOBLE firescreens can be
'made to measure' with your height,
width and, if relevant, depth dimensions.
Call for details.

Heights given for firescreens exclude handles.

Cardinal



Fixing kit 21500 available separately; see page 28 for details.

Black 20070 H605 W740 D140 (24x29x5.5")

Bishop



Fixing kit 21500 available separately; see page 28 for details.

Black 20071 H755 W685 D240/145 (30x27x9.5/5.5")

Heavy Stove Guard

*Please note with this screen the depth cannot be greater
than the width on any made to measure specials.*



*Fixing kit 21500 available separately;
see page 28 for details.*

Black 20073 H610 W760 D625 (24x30x24.5")



The Noble Collection

Laura (screen with tools)

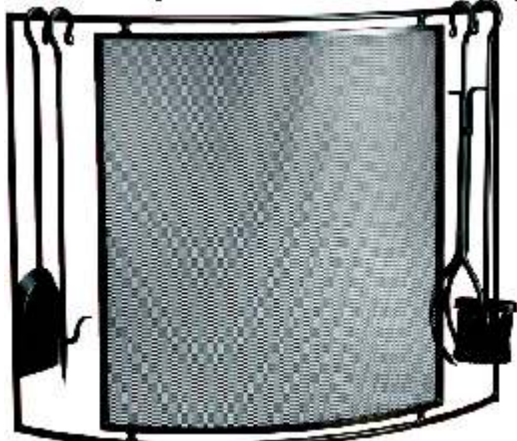

Not suitable for fixing kit.

Black 20044
H670 W810 D190
(26x32x7")

All NOBLE firescreens can be 'made to measure' with your height, width and, if relevant, depth dimensions. Call for details.

Heights given for firescreens exclude handles.

Bowed Front

H605 W610 D230 (24x24x9")



All Steel 20075



Alum Trim 20060



Brass Trim 20059



Black 20058

Fixing kit 21500 available separately; see page 28 for details.

Crescent

H600 W770 D175 (23.5x30x7")



Steel with Black Mesh 20077

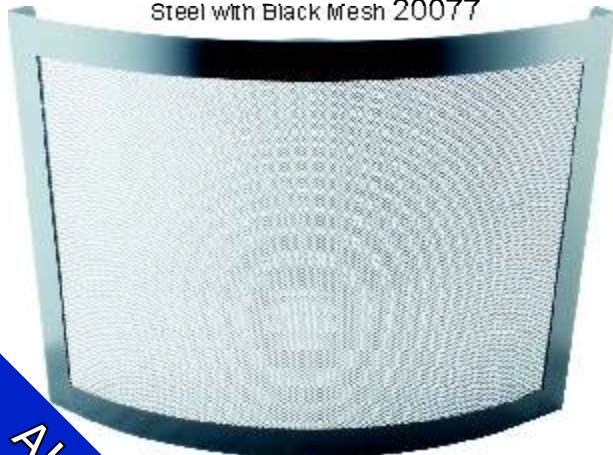

All Black 20076

Fixing kit 21500 available separately; see page 28 for details.

ALL BRITISH
MADE ITEMS
ON THIS
PAGE

Spark Guards

All Chrome



All Chrome
20066
H595 W520
(23x20.5")

Black & Brass



Black & Brass
20039
H595 W520
(23x20.5")



Black & Brass
20040
H610 W610
(24x24")



Domed Guard



Domed Guard
20051
H600 W555
(23.5x22")



Domed Guard
20054
H530 W485
(21x19")

All Black



All Black
21069
H630 W520
(25x20.5")

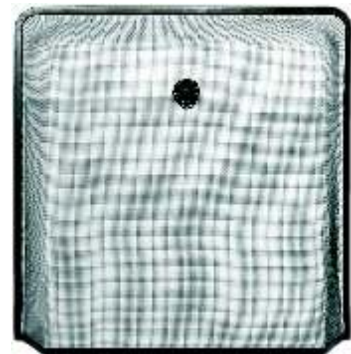

All Black
21070
H665 W665
(26x26")

Nursery Guards

Extending Nursery

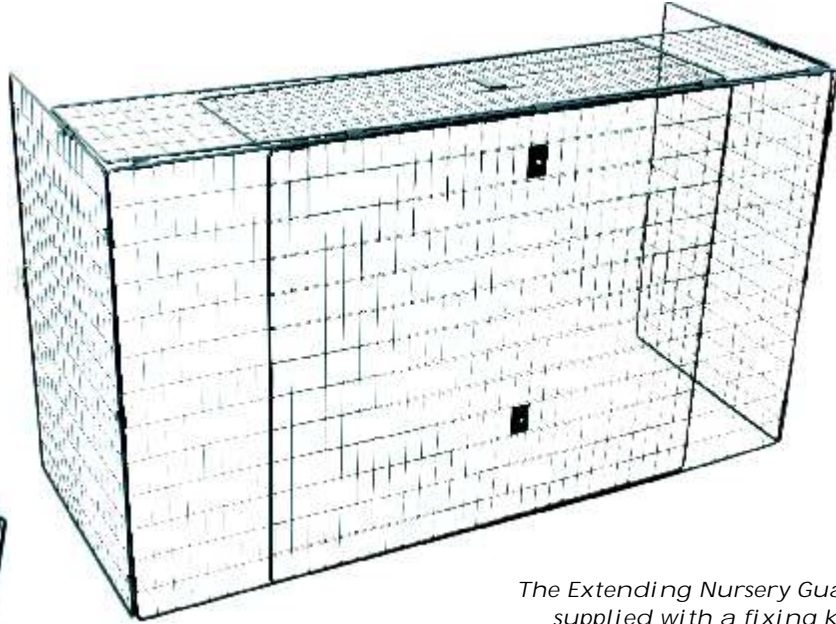

The Extending Nursery Guard is supplied with a fixing kit.



Extending Nursery Guard
20053
H670 W900/1525 D455
(26x36/60x18")



Measurements given for Nursery Guards are their overall dimensions.

Stove Nursery



The Stove Nursery Guard is supplied with a fixing kit.



21085
H750 W1190 D865
(29.5x47x34")

Nursery Guards

Bar Nursery

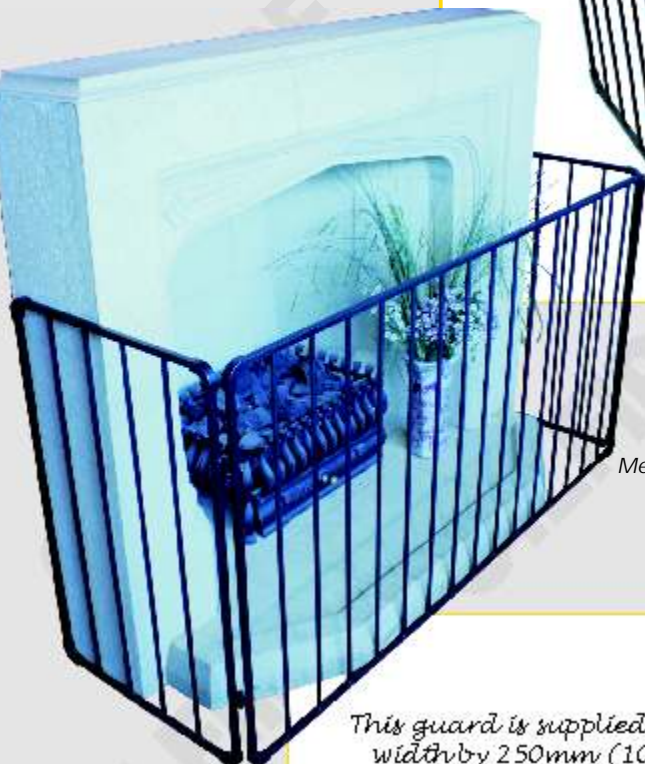

21086
H750 W1435 D480
(29.5x56.5x19")

Measurements given for Nursery Guards are their overall dimensions.



Both Bar Nursery Guards are supplied with fixing kits.

Large Bar Nursery

This guard is supplied with a centre panel which can be used to extend the width by 250mm (10") giving a dual width capability of either 1570 or 1820mm (62/72").

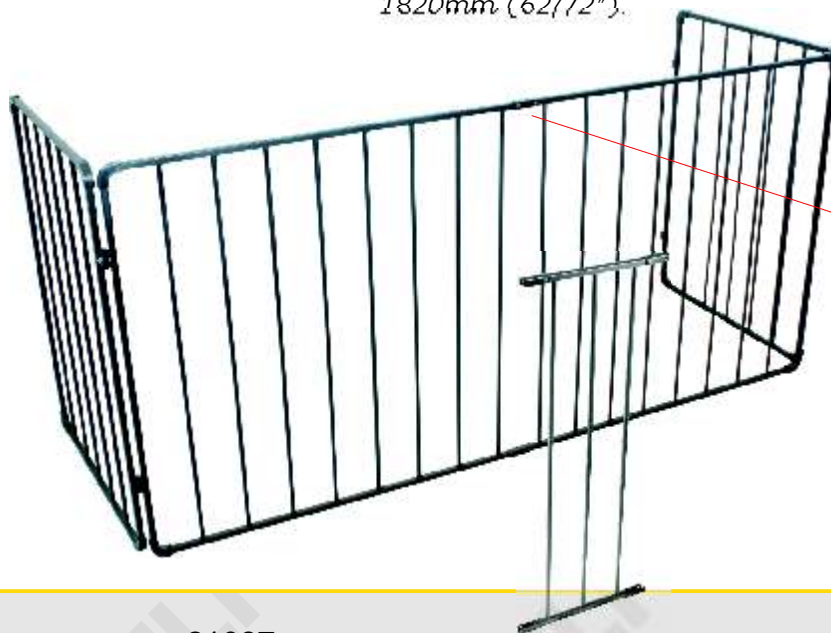

Joint detail

21087
H750 W1570/1820 D560
(29.5x62/72x22")

Coal Bucket Sets



All Black 23035
Dia. 240-280
(9.5-11")

Measurements given for coal buckets and hods exclude their handles.

Hadley Set (2)



Kenley Set (2)



Black & Chrome 23042/2
Dia. 270-330
(10.5-13")

Kenley Set (2)



All Black 23015/2
Dia. 270-330
(10.5-13")

Kenley Set (2)



Black & Solid Brass 23007/2
Dia. 270-330
(10.5-13")

Kenley Set (2)



Antique 23079/2
Dia. 270-330
(10.5-13")

Coal Buckets

Dryton Hod

Height 535 (21")

- A - 23014
Black Dryton Hod
- B - 23033
Zinc Dryton Hod
- C - 23003
Solid Brass Dryton Hod
- D - 23080
Antique
- E - 23034
Copper Bronze Hod



Norfolk Hod - Height 580 (23")



Black & Brass
23073

All Black
23072

Bicton Hod - Height 535 (21")



Black & Brass
22007

Black & Brushed Steel
22112

All Black
22010

Specified finishes relate to colour only and not material.

Kenley Medium - Dia. 270 (10.5")

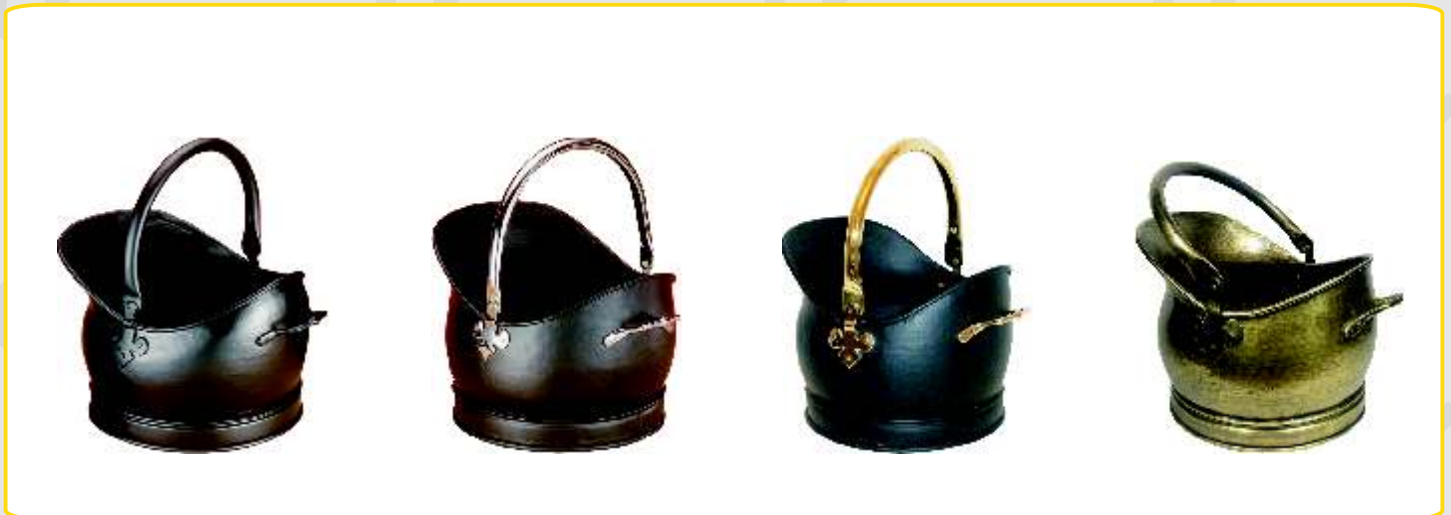

23015M
All Black

23042M
Black & Chrome

23007M
Black & Solid Brass

23079M
Antique

Measurements given for coal buckets and hods exclude their handles.



Adeney Dia. 250 (10")

- A - 22106
All Black
- B - 22108
Black & Brushed Steel
- C - 22107
Black & Brass



Kinton - Dia. 230 (9")



- 22008
Black & Brass
- 22105
Black & Brushed Steel
- 22104
All Black

Sutton - Dia. 280 (11")



- 22110
Black & Brass
- 22111
Black & Brushed Steel
- 22109
All Black

Plealey Dia. 255 (10")



23081
Antique

23050
All Black

Stanton

A - 23077
All Black with Shovel

B - 23078
Antique with Shovel

Dia. 240 (9.5")



A



B



Nobold

Dia. 250 (10")

Lawley

Dia. 250 (10")



23056
All Black
with Shovel

23037
All Black

Waterloo

Dia. 345 (13.5")

Rowton

Dia. 255 (10")

Astley

380W 205D (15x8")



23061
All Black

23054 - All Black

23016
All Black



23083
Wild Willow Log Basket
Full wild willow with external
handles and hessian lining
Height 381 Dia.508
(15x20")



See page 42
for basket kindling
holder

Measurements given for log baskets exclude their handles.



23084
Wild Willow Log Basket
Full wild willow with external handles
Height 381 Dia.508 (15x20")



23096
Buff Willow Tall Log Basket with Lining
Full double steamed buff willow with rustic stripe and hessian lining.
Height 560 Dia.510 (22x20")



23102
Round Rustic Log Basket
Full rustic and buff with integral handles
Height 390 Dia.480 (15.5x19")



23097
Buff Willow Tall Log Basket
Full double steamed buff willow with rustic stripe.
Height 560 Dia.510 (22x20")



23098
Set2 Deep Mill Log Baskets
Full wild willow with rope handles.
Large H385 W660 D470 (15x26x18.5")



23099
Set3 Buff Willow Log Baskets
Full buff double steamed and green willow
Large H390 W615 D460 (15.5x24x18")



Measurements given for log baskets exclude their handles.



23068
Set2 Open Ended Log Baskets
Full buff triple weave willow with rustic stripe
Large Basket H330 W368 D483
(13x14.5x19")



23100
Set3 Round Willow Log Baskets
Full green willow with rope handles
Large Basket Dia.495 (19.5")

Roden



23062
Black
H265 W510 D290
(10x20x11")

Roden



23082
Antique
H265 W510 D290 (10x20x11")

Felton



Supplied with Tools

The Felton is supplied flat packed and requires assembly.

23065
Black
H615 W400 D300
(24x16x12")

Basic



This Basic Log Carrier is part of a set of 'basic products' that are available. Also see the 'Basic' fire set on page 10 and the 'Basic' fire screen on page 22.

23107
Black
H330 W405 D330 (13x16x13")

Westley



23064
Black
H370 W535 D390 (14x21x15")

Log Carriers

season 2013/2014



Sling Carrier



23112

Black
H405 W710 D240
(16x28x9.5")

Ring (New)

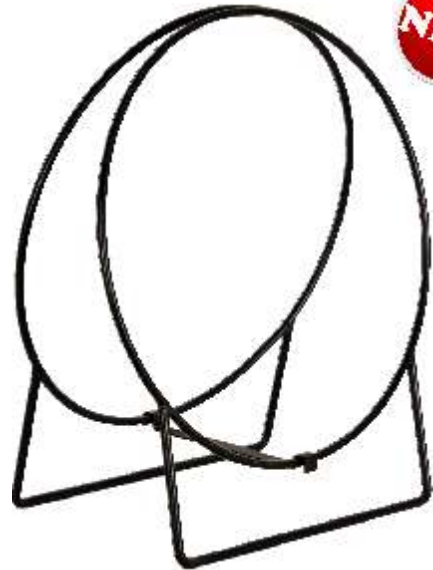

Easy assembly

23108

Black
H570 W330 D290
(22.5x13x11.5")

Ellie

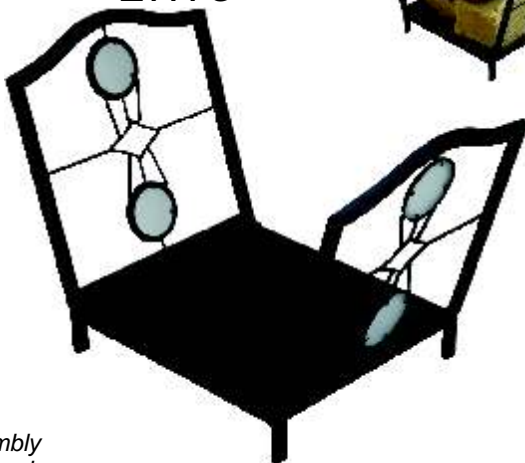

Assembly
required

23092

Black & Frosted Glass
H390 W550 D330
(15.5x22x13")

Hopton



Assembly
required

23087

Black
H350 W575 D340
(14x22.5x13.5")



23101
H130 W305 D200
(5x12x8")
Excludes handles

This existing coal bucket is also ideal for the popular shorter kindling and holds the full retail sales pack.

Astley

23016
Black
380W 205D (15x8")



CW Kindling Basket

Will hold just over half of the retail sales pack



CW Kindling Holder



Will hold just under half of the retail sales pack

23095
Black
H180 W220
(7x8.75")

Ring



Suitable for all kindling

23090
Black
H230 W215 D215 (9x8.5x8.5")

Marton



Suitable for kindling of around 250mm long

23091
Black
H240 W215 (9.5x8.5")

CALFIRE

Log Racks

season 2013/2014

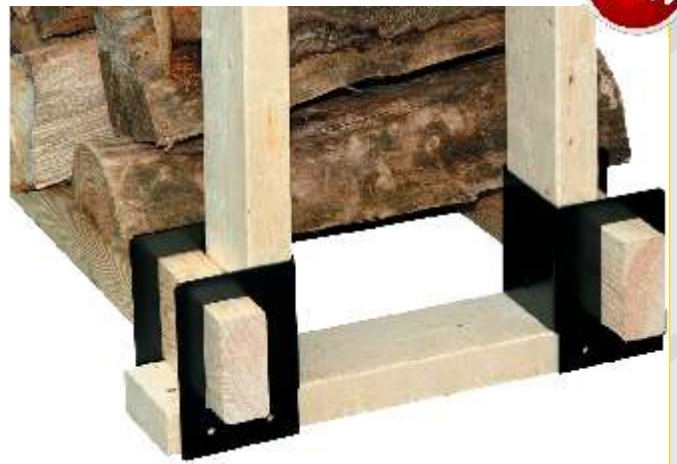

Supply your own timber to create the log rack you require

Log Rack Brackets

23111

Set4

Brackets fits standard planed wood size 38 x 89mm; this is available from most hardware stores

Each bracket measures: H150 W95 D100 (6x3.75x4")

4' Log Rack

23109

H1220 W1220 D340 (48x48x13.5")

CALFIRE
The Fireside Collection



Assembly required

Supply your own timber to create the log rack you require

Log Rack Ends

23110

Set2

Brackets fits standard planed wood size 38 x 89mm; this is available from most hardware stores.

Each frame measures: 1120H 290W (44"x11.5")



Traditional Fire Backs - up to 24" wide

CALFIRE are proud to announce that they acquired the supply of the highly acclaimed range of quality castings from Kingsworthy Foundry in the autumn of 2010.

These Premier quality castings, British Made fire baskets, fire dogs etc from the Kingsworthy range are detailed within pages 44-57 of this catalogue.

Where Premier range alternatives are available, these are cross referenced within the catalogue.

Rose & Portcullis



35185
W395 H535 (15.5x21")

Phoenix



35225
W455 H560 (18x22")

Ironfounder



35226
W480 H505 (19x20")

Tree of Life



35186
W495 H730 (19.5x28.75")

Individual sizes & weights are provided for guidance only; due to the manufacturing process the actual product may vary.

Two Cherubs



35227
W495 H680 (19.5x26.75")

Royal Coat of Arms



35188
W535 H655 (21x26")

Fleur-de-llys



35184
W575 H415 (22.5x16.5")

Lion



35224
W590 H415 (23.25x16.25")

Traditional Fire Backs - up to 24" wide

With our range of traditional cast iron firebacks, there is something to fit the smaller fireplace opening through to the larger inglenook.

Most of the firebacks are copies of authentic originals, some of which date back to the seventeenth century, and are ideal for those trying to maintain the historical charm of an old inglenook.

Sizes range from 405mm (16") wide to the 1065mm (42") wide 'Large Royal Oak' fireback; probably the largest fireback now available within the UK.

Coat of Arms
1635



35128
W595 H510 (23.5x20")

Shield



35229
W590 H575 (23.25x22.5")

Individual sizes & weights are provided for guidance only; due to the manufacturing process the actual product may vary.

Plain



35129
W605 H495 (23.75x19.5")

Pikemen



35228
W590 H550 (23.5x22")



The above brick-backed fireplace is protected by a K7 Pikemen cast iron Fireback with Barley Twist Dogs supporting a 24" Swansnest basket. The fireplace is complimented with the Regent companion set.

Traditional Fire Backs - up to 30" wide

*Kingsworthy Foundry
traditional quality fireside
accessories for log and
coal burning fires, now
available exclusively to the
trade from CALFIRE*

The thickness of our firebacks vary from ½" to 2" according to size. All firebacks are painted black. To install simply lean the fireback against the rear of the fireplace. Some firebacks are still hand moulded and cast in much the same way as they have been for generations. Apart from the aesthetic value, firebacks prevent scorching of the rear brickwork and help to radiate heat - a point worth remembering when installing a gas log or coal effect fire as they are equally effective with this type of appliance as with the traditional natural log or coal fire.

Rope Twist

K37
42Kg



35163
W660 H495 (26x19.5")

Large Flowers

K5
112Kg



35160
W725 H885 (28.5x34.75")

Laughing Lion

K13
71Kg



35127
W725 H650 (28.5x25.5")

Individual sizes & weights are provided for guidance only; due to the manufacturing process the actual product may vary.

Lion & Unicorn

K1
70Kg



35126
W735 H660 (28.75x26")

Plain

K13P
57Kg



35140
W740 H665 (29x26")

Horse Chestnut

K51
68Kg



35158
W740 H645 (29.25x25.25")

Traditional Fire Backs - for the larger inglenook



Please note: The firebacks on Pages 46-48 are particularly heavy, therefore in the interests of Health & Safety we recommend 2/3 people are used to lift or move them.

The thickness of our firebacks vary from ½" to 2" according to size. All firebacks are painted black. To install simply lean the fireback against the rear of the fireplace. Some firebacks are still hand moulded and cast in much the same way as they have been for generations. Apart from the aesthetic value, firebacks prevent scorching of the rear brickwork and help to radiate heat - a point worth remembering when installing a gas log or coal effect fire as they are equally effective with this type of appliance as with the traditional natural log or coal fire.

K46
129Kg

Large Shield



35159

W810 H1070 (31.75x42")

Royal Oak Midi

K22
113Kg



35125

W845 H720 (33.25x28.5")

Individual sizes & weights are provided for guidance only; due to the manufacturing process the actual product may vary.

Fairfax

K47
79Kg



35187

W860 H685 (34x27")



The Royal Oak Fireback is shown here with Barley Twist Dogs supporting a 30" 4 sided Swansnest basket.

Traditional Fire Backs - for the larger inglenook

*Kingsworthy Foundry
traditional quality fireside
accessories for log and
coal burning fires, now
available exclusively to the
trade from CALFIRE*

The thickness of our firebacks vary from ½" to 2" according to size. All firebacks are painted black. To install simply lean the fireback against the rear of the fireplace. Some firebacks are still hand moulded and cast in much the same way as they have been for generations. Apart from the aesthetic value, firebacks prevent scorching of the rear brickwork and help to radiate heat - a point worth remembering when installing a gas log or coal effect fire as they are equally effective with this type of appliance as with the traditional natural log or coal fire.

Medieval Large

K41L
114Kg



35183

W875 H805 (34.5x31.5")

Lion & Unicorn

K4
148Kg



35162

W965 H775 (38.25x30.5")

Individual sizes & weights are provided for guidance only; due to the manufacturing process the actual product may vary.

Royal Oak Large

K22L
180Kg



35124

W1070 H835 (42x33.25")



Please note: The firebacks on Pages 46-48 are particularly heavy, therefore in the interests of Health & Safety we recommend 2/3 people are used to lift or move them.

Slide-in Fire Backs

These "slide-in" cast iron firebacks are designed to fit in specific firebaskets as shown on pages 53-54.

Individual sizes & weights are provided for guidance only; due to the manufacturing process the actual product may vary.

Fleur-de-lys

Plain

Lion

K57F
9Kg



K57P
9Kg



K57L
9Kg



Plain fireback shown with Modula Mini Basket

35150

W395 H275 (15.5x10.75")

35151

W395 H280 (15.5x11")

35221

W395 H270 (15.5x10.5")



Fleur-de-Lys fireback shown with Popular Black Knobs Standard Basket

Fleur-de-lys

Plain

K58F
14Kg



K58P
14Kg



35121

W470 H360 (18.5x14.25")

35154

W460 H365 (18x14.25")

Fleur-de-lys

Plain

Lion

K59F
18Kg



K59P
18Kg



K59L
17Kg



Lion fireback shown with Popular Plain Medium Basket

35153

W550 H360 (21.75x14.25")

35152

W560 H365 (22x14.5")

35223

W550 H350 (21.5x13.75")

Reeded Panels



*Kingsworthy Foundry
traditional quality
fireside accessories for
log and coal burning
fires, now available
exclusively to the trade
from CALFIRE*

Please note: The larger reeded panels detailed on this page are particularly heavy, therefore in the interests of Health & Safety we recommend 2/3 people are used to lift or move them.



K56

The above wood-panelled fireplace interior is lined with cast iron Reeded Panels and a 24" Swansnest basket supported by Barley Twist Dogs.

Individual sizes & weights are provided for guidance only; due to the manufacturing process the actual product may vary.

Cross section showing Reeded form



Reeded Panels are used where the complete interior of the fireplace is required to be lined, as is the case of the re-building of a Georgian fireplace, or when reproducing a "period style fireplace". A cast iron firegrate with integral small back should be used with this type of fireplace (as example above).

35132 W405 H915 (16x36") 41Kg
35133 W405 H1015 (16x40") 43Kg
35134 W455 H915 (18x36") 46Kg
35135 W455 H1015 (18x40") 49Kg

35136 W760 H915 (30x36") 78Kg
35137 W760 H1015 (30x40") 87Kg
35138 W1220 H1015 (48x40") 145Kg
35139 W1525 H1015 (60x40") 156Kg

*Sizes approximate - please allow
12mm (1/2") tolerance.*

Traditional Firedogs

Firedogs are used as ornamental supports for Dog Grate/Baskets. Consideration should be given to the extra width required in a fireplace opening to accommodate the feet span of the dogs.

Cast Iron Dogs can, if preferred be used without a Dog Basket. Seasoned logs can be lent against the cross bars and burnt on the hearth base, providing there is a good draw in the chimney.

All Fire Dogs sold as pairs

Colonial Canterbury

Although not from the Kingsworthy Range these quality British Made Dogs must be considered part of our Premier Castings Range.



34012
Solid Brass
Colonial
H360 (14.25")

34013
Solid Brass
Canterbury
H370 (14.5")

Scroll Dogs



Medium 34170

W260 D515 H440 (10.25x20.25x17.25")

Large 34171

W345 D620 H560 (13.5x24.5x22")

Ball Head Dogs



Medium 34115

W260 D525 H415 (10.25x20.75x16.25")

Large 34116

W340 D660 H590 (13.5x26x23.25")

Mulling Dogs



Medium 34117

W250 D515 H475 (9.75x20.25x18.75")

Large 34118

W310 D605 H630 (12.25x23.75x24.75")

Pinnacle Dogs (Cast Iron)



35122

W195 D485 H405 (7.75x19x16")

Barley Twist Dogs (Cast Iron)



35123

W255 D465 H430 (10x18.25x17")

Column Dogs (Cast Iron)



35164

W210 D465 H380 (8.25x18.25x15")

Tapered Firegrates

*Kingsworthy Foundry
traditional quality fireside
accessories for log and coal
burning fires, now available
exclusively to the trade
from CALFIRE*

*These Tapered Firegrates
are supplied as shown in the
pictures. Draught Covers, Ash
Pans and Replacement Grids
are available separately as
detailed in the product
information.*

Portcullis & Swan

Dimensions:

16"- W400/255 D240 H290 (15.75/10x9.5x11.5")
18"- W450/300 D240 H290 (17.75/11.75x9.5x11.5")

G8

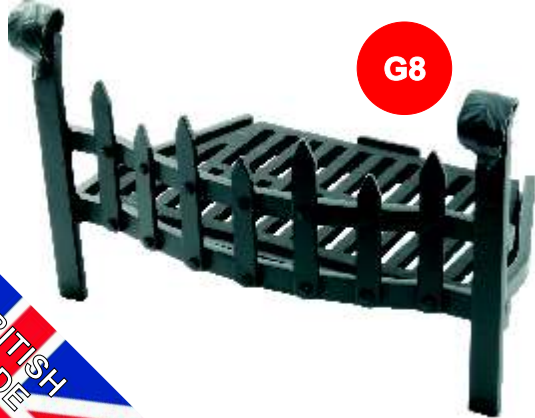

16" P & S Firegrate 34172

18" P & S Firegrate 34173

16" Ash Pan 34137

18" Ash Pan 34138

16" Replacement Grid 35141

18" Replacement Grid 35142

Portcullis & Urns

Dimensions:

16"- W385/255 D240 H275 (15.25/10x9.5x10.75")
18"- W440/300 D240 H290 (17.25/11.75x9.5x11.5")

G2

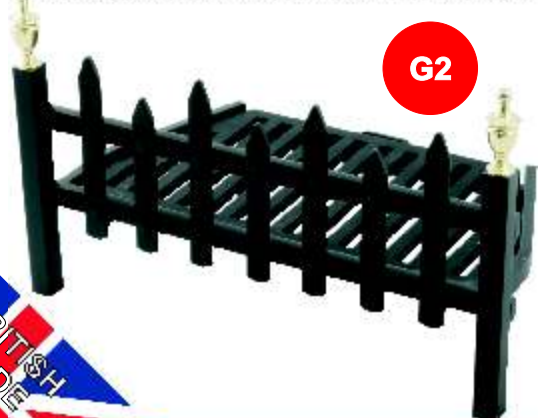

16" P & U Firegrate 34174

18" P & U Firegrate 34175

16" Ash Pan 34137

18" Ash Pan 34138

16" Replacement Grid 35141

18" Replacement Grid 35142

Ultra

Dimensions:

16"- W395/255 D240 H175 (15.5/10x9.5x7")
18"- W445/290 D240 H175 (17.5/11.5x9.5x7")

G55

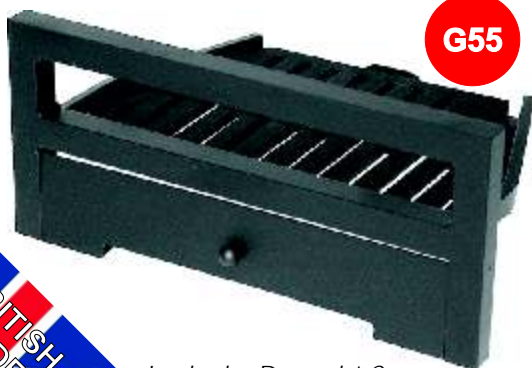

Includes Draught Cover

16" Ultra Firegrate 34101

18" Ultra Firegrate 34102

16" Ash Pan 34137

18" Ash Pan 34138

16" Replacement Grid 35141

18" Replacement Grid 35142

Windsor Inset

Dimensions:

16"- W405/240 D280 H220 (16/9.5x11x8.75")
18"- W455/285 D285 H220 (18/11.25x11.25x8.75")

G11



Includes Draught Cover

16" Windsor Inset 35130

18" Windsor Inset 35131

16" Ash Pan 34137

18" Ash Pan 34138

16" Replacement Grid 35130G

18" Replacement Grid 35131G



British Firebaskets - Please note that the cast iron replaceable fire grids and the slot-in firebacks are manufactured in China.

*Kingsworthy Foundry
traditional quality fireside
accessories for log and
coal burning fires, now
available exclusively to the
trade from CALFIRE*

Replacement
grids are available
for all British Firebaskets.
See Page 57 and
Price List for
details.

CALFIRE
The Fireside Collection



Standard
fireback designs

See page 49 for larger
illustrations of the available
Standard fireback options.



Medium
fireback designs

See page 44 for larger
illustrations of the available
Medium K43 fireback options.

Portcullis with
Swan Neck

G20



Portcullis with Swan
Neck & Back

G21



Dimensions:

Standard - W485 D350 H335 (19x13.75x13.25")
Medium - W640 D350 H335 (25.25x13.75x13.25")
Large - W735 D455 H425 (29x18x16.75")

Ashpans, Draught Covers and replacement Grids available - See Price List for details

G21 with Fleur-de-Lys Back:

Standard 34191
Medium 34194
(Standard F-D-L shown):

G21 with Plain Back:

Standard 34192

G21 with Lion Back:

Standard 34193
Medium 34196

G20 Basket:

Standard 34188 - Medium 34189 - Large 34190

When fitting the optional slot-in firebacks the overall height will increase by approx. 135mm (5.25") with the Standard size and approx. 190mm (7.5") with the Medium Sizes

Ducksnest

G24



Ducksnest for Dogs
(Shown with British Ball Head Dogs)

G26



G24 Dimensions:

Standard - W545 D275 H250 (21.5x10.75x9.75")
Medium - W615 D330 H260 (24.25x13x10.25")
Large - W750 D440 H285 (29.5x17.25x11.25")

Ashpans, Covers and replacement Grids available - See Price List for details

G26 Dimensions:

Standard W620/545 D275 H150 (24.5/21.5x10.75x6")
Medium W750/615 D330 H150 (29.5/24.25x13x6")
Large W850/750 D440 H180 (33.5/29.5x17.25x7")

Dimensions do not include Firedogs. Depending on choice, Firedogs will lift these baskets by 6-7" and extend the width by 6-12". Please see page 51 for Firedog dimensions.

G24 Basket:

Standard 34109 Medium 34110
Large 34111

53

G26 Ducksnest for Dogs:

Standard 34112 Medium 34113
Large 34114

ALL BRITISH
MADE ITEMS
ON THIS
PAGE



British Firebaskets - Please note that the cast iron replaceable fire grids and the slot-in firebacks are manufactured in China.

Popular - Black Knobs



G14

Popular - Black Knobs with Back



G15

Dimensions:

Mini - W450 D290 H310 (17.75x11.5x12.25")

Standard - W520 D345 H345 (20.5x13.5x13.5")

Medium - W605 D345 H345 (23.75x13.5x13.5")

Ashpans, Draught Covers and replacement Grids available - See Price List for details

G15 with Fleur-de-Lys Back:

Mini 34152

Standard 34155

Medium 34158

(Standard F-D-L shown)

G15 with Plain Back:

Mini 34153

Standard 34156

Medium 34159

G15 with Lion Back:

Mini 34154

Standard NA

Medium 34160



See page 49 for larger illustrations of the available fireback options.

G14 Basket:

Mini 34106 - Standard 34107 - Medium 34108

When fitting the optional slot-in firebacks the overall height will increase by approx. 90mm (3.5") with the Mini size and approx. 135mm (5.25") with the Standard and Medium Sizes

Popular Plain



G61

Popular Plain with Back



G63

Dimensions:

Mini - W420 D275 H250 (16.5x10.75x9.75")

Standard - W490 D330 H250 (19.25x13x9.75")

Medium - W580 D345 H250 (22.75x13.5x9.75")

Ashpans, Draught Covers and replacement Grids available - See Price List for details

G63 with Fleur-de-Lys Back:

Mini 34161

Standard 34164

Medium 34167

G63 with Plain Back:

Mini 34162

Standard 34165

Medium 34168

G63 with Lion Back:

Mini 34163

Standard NA

Medium 34169

(Medium Lion shown):

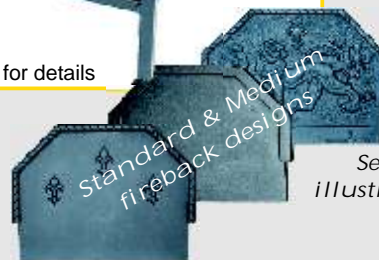

See page 49 for larger illustrations of the available fireback options.

G61 Basket:

Mini 34103 - Standard 34104 - Medium 34105

When fitting the optional slot-in firebacks the overall height will increase by approx. 145mm (5.75") with the Mini size and approx. 235mm (9.25") with the Standard and Medium Sizes

Modula

Includes Draught Cover



G68

Modula with Back

Includes Draught Cover



G69

Dimensions:

Mini - W430 D280 H255 (17x11x10")

Standard - W495 D335 H255 (19.5x13.25x10")

Medium - W585 D335 H255 (23x13.25x10")

Ashpans and replacement Grids available - See Price List for details

G69 with Fleur-de-Lys Back:

Mini 34179

Standard 34182

Medium 34185

G69 with Plain Back:

Mini 34180

Standard 34183

Medium 34186

(Mini Plain shown):

G69 with Lion Back:

Mini 34181

Standard NA

Medium 34187

G68 Basket: Mini 34176 - Standard 34177 - Medium 34178

When fitting the optional slot-in firebacks the overall height will increase by approx. 180mm (7") with the Mini size and approx. 260mm (10.25") with the Standard and Medium Sizes

Fire Baskets Cast Iron



Adam No.2



C2
40Kg

Cover sold separately

C2 Basket 35120 W570 D330 H635 (22.5x13x25")
(Alternative chrome finials and knob available on request)
Cover 35193

Spanish with Back



C9Std
23Kg



C9Med
28Kg

Combined Cover/Ashpan's sold separately

C9 Standard 35176 W470 D290 H455 (18.5x11.5x18")
Combined Cover/Ashpan 35191

C9 Medium 35177 W545 D300 H465 (21.5x11.75x18.25")
Combined Cover/Ashpan 35192

Individual weights are provided for guidance only; the actual product may vary slightly.

Cromwell



C11

Weights:
Standard - 16.5Kg
Large - 22Kg

Combined Cover/Ashpan's sold separately

Cromwell with Back

NEW
Re-introduced
2013



C11B
25Kg

Combined Cover/Ashpan's sold separately

C11 Standard 35118 W430 D275 H150 (17x10.75x6")
C11 Large 35119 W535 D305 H150 (21x12x6")
Combined Cover/Ashpan: Standard 35195 - Large 35196

C11B Standard 35239 W430 D275 H335 (17x10.75x13.25")
Combined Cover/Ashpan - Standard 35195
(Fireback Only K60 35161)

Fire Baskets Cast Iron

Swansnest for dogs

C13



Shown on G36 Pinnacle Dogs
Dimensions do not include firedogs

- C13 18" **35166** W440 D280 H165 (17.25x11x6.5")
- C13 24" **35167** W590 D320 H165 (23.25x12.5x6.5")
- C13 30" **35168** W730 D405 H165 (28.75x16x6.5")
- C13 36" **35169** W900 D415 H165 (35.5x16.25x6.5")

Swansnest freestanding

C14



These items can be supplied with Patterned or Plain Legs.
Patterned Legs shown.
Dimensions as C13 range with Height increased to 240mm (9.5")

- | | |
|----------------------|----------------------|
| With Patterned Legs: | With Plain Legs: |
| C14 18" 35207 | C14 18" 35208 |
| C14 24" 35209 | C14 24" 35210 |
| C14 30" 35211 | C14 30" 35212 |
| C14 36" 35213 | C14 36" 35214 |

Swansnest - 3 sided for dogs

C20



Shown on G40 Barley Twist Dogs
Dimensions do not include firedogs

- C20 18" **35145** W445 D305 H165 (17.5x12x6.5")
- C20 24" **35146** W610 D355 H165 (24x14x6.5")
- C20 30" **35147** W750 D415 H165 (29.5x16.25x6.5")
- C20 36" **35148** W890 D415 H165 (35x16.25x6.5")
- C20 42" **35149** W1040 D415 H165 (41x16.25x6.5")

Swansnest - 3 sided freestanding

C21



These items can be supplied with Patterned or Plain Legs.
Plain Legs shown.
Dimensions as C20 range with Height increased to 240mm (9.5")

- | | |
|----------------------|----------------------|
| With Patterned Legs: | With Plain Legs: |
| C21 18" 35197 | C21 18" 35198 |
| C21 24" 35199 | C21 24" 35200 |
| C21 30" 35201 | C21 30" 35202 |
| C21 36" 35203 | C21 36" 35204 |
| C21 42" 35205 | C21 42" 35206 |

Log Cradle for dogs

C30



Shown on G41 Column Dogs.
Use with bar at front or back.
Dimensions do not include firedogs

- C30 18" **35155** W445 D305 H100 (17.5x12x4")
- C30 24" **35156** W610 D355 H100 (24x14x4")
- C30 30" **35157** W750 D415 H100 (29.5x16.25x4")

Log Cradle freestanding

C31



These items can be supplied with Patterned or Plain Legs.
Plain Legs shown.
Dimensions as C30 range with Height increased to 165mm (6.5")
Use with bar at front or back

- | | |
|----------------------|----------------------|
| Patterned Legs: | Plain Legs: |
| C31 18" 35215 | C31 18" 35216 |
| C31 24" 35217 | C31 24" 35218 |
| C31 30" 35219 | C31 30" 35220 |

Miscellaneous

Ash Pans

A20



Ashpan Covers

A21



See price list for available sizes of Ashpans & Ashpan Covers

Kingsworthy Foundry traditional quality fireside accessories for log and coal burning fires, now available exclusively to the trade from CALFIRE

Milner Grids

To fit Tapered Grates G2, G8 & G55 on Page 51

A18



Rectangular Grids

See Price List for details of which grid is used on which basket

A18

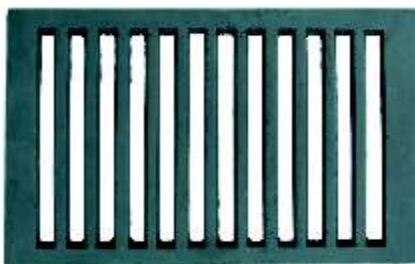

Loose Bars

Used in conjunction with Rectangular Grids on some baskets.

A18



35141 405mm (16")
35142 455mm (18")

35171 Ref.B 395x240mm (15.5x9.5")
35172 Ref.C 455x305mm (18x12")
35173 Ref.F (Sold in pairs) each one measures 215x280mm (8.5x11")
35174 Ref.G 375x220mm (14.75x8.75")

35143 Standard 250x30mm (9.75x1.25")
35144 Medium 280x30mm (11x1.25")

Popular Scraper



Beetle Bootjack



35181
W380 D240 H180
(15x9.5x7")

35178 Small
L230 W105 H70
(9x4.25x2.75")

Traditional Fire Baskets - See Price List for Gas Burner Availability.

Chalfont



Ashcovers and ashpans are separate items.

- 21" Chalfont Black 34094
- W552 D250 H390 (22x10x15")
- Cover 21" Black 34045
- W460 H95 (18x4")
- Ashpan & Lifter 34096



Cottage



This item is reversible and can be used with an All Black front or a Polished front.

Solid Fuel Kit sold separately

- Small Cottage 35057 W495 D305 H370 (19.5x12x14.5")
- Large Cottage 35049 W540 D305 H480 (22x12x19")
- Solid Fuel Kit SFK26 35113

The Solid Fuel Kit for this product includes only the fire grid.

Solid Fuel Kit sold separately

Castle



- Castle Basket 35090
- W570 D280 H440 (22x11x17")
- Solid Fuel Kit SFK22C 35114

Solid Fuel Kit sold separately

Art Deco



The Solid Fuel Kit for this product includes only the fire grid.

- Art Deco Black 35048
- W545 D245 H475 (22x10x19")
- Solid Fuel Kit SFK11 35111

Individual sizes & weights are provided for guidance only; due to the manufacturing process the actual product may vary.

Valencia with Back



Solid Fuel Kit sold separately

See Page 54 for CALFIRE PREMIER RANGE Alternatives

- 18" Black 35102 W470 D290 H475 (18.5x11.4x18.7")
- 18" Solid Fuel Kit SFK12 35112
- 21" Black 35103 W550 D290 H500 (21.7x11.4x19.7")
- 21" Solid Fuel Kit SFK14 35116

Valencia



Solid Fuel Kits sold separately

- 16" 35099 W400 D330 H220. Solid Fuel Kit SFK23 35110
- 18" 35100 W470 D335 H220. Solid Fuel Kit SFK12 35112
- 21" 35101 W550 D330 H220. Solid Fuel Kit SFK14 35116

Modern Fire Baskets - See Price List for Gas Burner Availability.

Neon - Dimensions: W380 D280 H225 (15x11x9")



*Solid Fuel Kit sold separately
Shown with backs fitted although these can be removed*

Polished Neon 35035
Solid Fuel Kit SFK23 35110

Black Neon 35036
Solid Fuel Kit SFK23 35110

Elan No Back - Dimensions: W435 D295 H210 (17x12x8")



Solid Fuel Kit sold separately

Polished Elan No Back 35037
Solid Fuel Kit SFK12 35112

Black Elan No Back 35038
Solid Fuel Kit SFK12 35112



With these baskets choose a black finish for use with solid fuel as polished surfaces change colour with heat. Polished surfaces can also be affected by the heat from gas appliances although the resultant discolouration will be much less noticeable.

Modern Fire Baskets - See Price List for Gas Burner Availability.

Krypton - Dimensions: W535 D260 H190 (21x10.25x7.5")



Solid Fuel Kit sold separately
Shown with and without back fitted

Polished Krypton 35092
Solid Fuel Kit SFK22K 35115

Black Krypton 35091
Solid Fuel Kit SFK22K 35115

With the Krypton & Elan Baskets choose a black finish for use with solid fuel as polished surfaces change colour with heat. Polished surfaces can also be affected by the heat from gas appliances although the resultant discolouration will be much less noticeable.

See price list for gas burner availability.



Elan With Back

Dimensions: W460 D305 H410 (18x12x16")



Solid Fuel Kit sold separately

Black Elan With Back 35040
Solid Fuel Kit SFK12 35112



Solid Fuel Kit sold separately

Polished Elan With Back 35039
Solid Fuel Kit SFK12 35112

Modern Fire Baskets - See Price List for Gas Burner Availability.

The Matrix

Dimensions:
W515 D300 H395
(20x12x15.5")

With the Matrix Baskets choose a black finish for use with solid fuel as polished surfaces change colour with heat. Polished surfaces can also be affected by the heat from gas appliances although the resultant discolouration will be much less noticeable.



The Matrix Back 35093
Solid Fuel Kit SFK14 35116

Solid Fuel Kit sold separately



The Matrix Polished 35094
Solid Fuel Kit SFK14 35116

Gas Burners

Calfire offer a range of Gas Fires suitable for use with many of our range of Traditional & Modern Baskets.

LPG Fires are available to order.

See price list for details. Gas Burner codes from 37005



Shown with Cadiz Basket

Solid Fuel Fret Sets

- Dimensions given for Fret Sets are category sizes relating to standard milner firebacks -



See Page 52 for CALFIRE PREMIER RANGE alternatives



Includes Style Fret, Grate, Ashpan & Ashpan Tool.

Style Solid Fuel Kit
35080 W400 (16")



Includes Beacon Fret, Grate, Ashpan & Ashpan Tool.

Beacon Solid Fuel Kit
35076 W400 (16")
35104 W450 (18")



Includes Joyce Fret, Grate, Ashpan & Ashpan Tool.

Joyce Solid Fuel Kit
35081 W400 (16")

All Night Burners - *Dimensions for All Night Burners are category sizes relating to standard milner firebacks*

Fire Grates and Ash Pans are included with all 'All Night Burners'



Lattice All Night Burner
35077 W400 (16")
35078 W450 (18")

Regency All Night Burner
35079 W400 (16")

Star All Night Burner
35105 W400 (16")
35106 W450 (18")

Fire Grates - *Dimensions for Fire Grates are category sizes relating to standard milner firebacks*

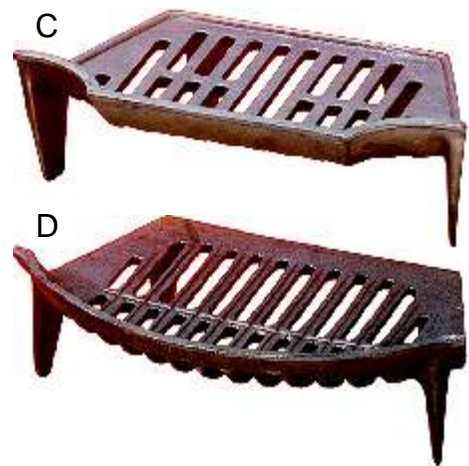
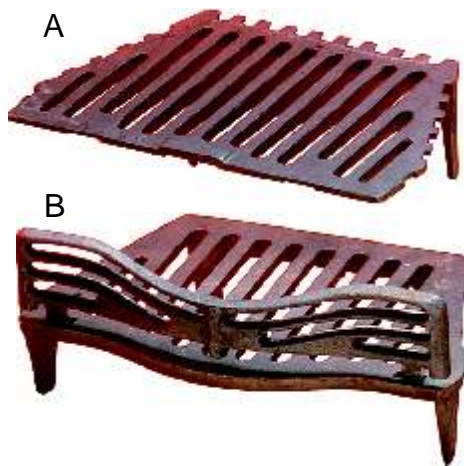

A - Regal Grate
35001 W400 (16")

B - Joyce Grate & Front
35002 W400 (16")
35003 W450 (18")

C - Guardette Grate
35004 W400 (16")
35005 W450 (18")

D - Standard Grate
35006 W400 (16")
35007 W450 (18")

Ash Pans - *Dimensions for Ash Pans are category sizes relating to standard milner firebacks*



E - Ashpan & Lifter
34077 W400 (16")

F - Standard Ashpan
34093 W400 (16")
34092 W450 (18")

Kettle

Weight
4Kg



This item is water proof but is coated in a protective paint on the inside, therefore it is recommended for decorative use only.

35240
Kettle with Coil Handle
W260 D210 H230 (10x8.25x9")

Ash Carriers



35075

Room Heater Ash Carrier to suit Charnwood, Parkray & Trianco
W405 H520 (16x20")



35074

Open Fire Ash Carrier to suit 16" & 18" Open Fires
W430 H330 (17x13")

Solid Fuel Frets

Castle



Castle Black
33070 16"
33072 18"

N Type



N Type Black
33066 16"
33068 18"

In addition to the Frets featured on this page you can also choose any of the cast iron frets from pages 65-67.

Style

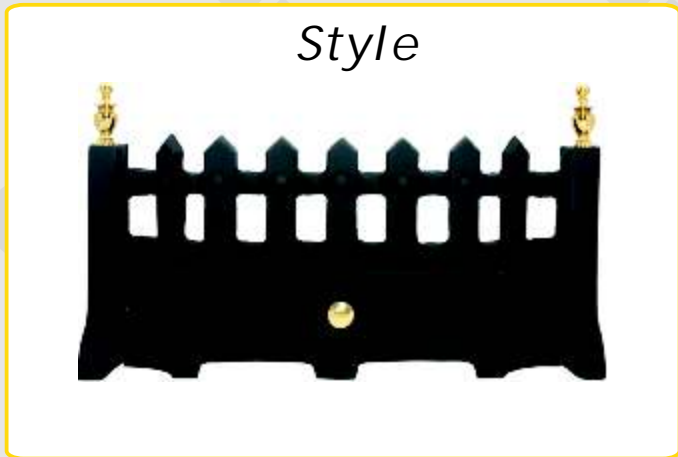

Style Black
33074 16"
33075 18"

Beacon

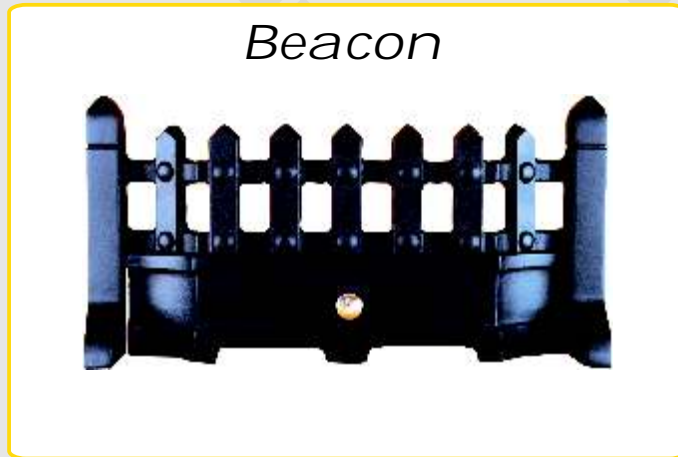

Beacon Black
33021 16"
33024 18"

Frets - Dimensions given for Frets are category sizes relating to standard milner firebacks.

Grace



Black
33079 W400 (16")
33082 W450 (18")

Brass
33080 W400 (16")
33083 W450 (18")

Chrome
33081 W400 (16")
33084 W450 (18")

Blenheim Solid Cover



Black Cast Iron Solid
33011 W400 (16")
33019 W450 (18")



Brass Solid
33014 W400 (16")
33017 W450 (18")

Chrome
33077 W400 (16")
33078 W450 (18")

65

Black & Brass Solid
33015 W400 (16")
33018 W450 (18")

Black & Polished Solid
33016 W400 (16")
33020 W450 (18")

Frets - Dimensions given for Frets are category sizes relating to standard milner firebacks.

Balmoral



Black Balmoral
33041 W400 (16")



Brass
33005 W400 (16")



Black & Brass
33006 W400 (16")

Black & Chrome
33076 W400 (16")

Daisy



Black
33085 W400 (16")
33090 W450 (18")



Brass
33086 W400 (16")
33091 W450 (18")



Chrome
33088 W400 (16")
33093 W450 (18")



Black & Brass
33087 W400 (16")
33092 W450 (18")



Black & Chrome
33089 W400 (16")
33094 W450 (18")

Frets - Dimensions given for Frets are category sizes relating to standard milner firebacks.

Bauhaus



With the Bauhaus Fret choose a black finish for use with solid fuel as polished surfaces change colour with heat. Polished surfaces can also be affected by the heat from gas appliances although the resultant discolouration will be much less noticeable.

Black Cast Iron
33043 W400 (16")
33046 W450 (18")

Antique
33045 W400 (16")
33048 W450 (18")

Polished
33044 W400 (16")
33047 W450 (18")

Fire Trims - Dimensions given for Fire Trims are category sizes relating to standard milner firebacks



All Fire Trims have a height of 560 (22"). Special sizes and Arched Trims are available to order, 3 or 4 sided, in various material finishes. Contact our Sales Office for details.

A. Polished Stainless Steel
36009 W400 (16")
36010 W450 (18")
50 (2") Front, 50 (2") Return

C. Black
36007 W400 (16")
36008 W450 (18")
50 (2") Front, 50 (2") Return

D. Brass
36001 W400 (16")
36002 W450 (18")
50 (2") Front, 50 (2") Return
and
36003 W400 (16")
36004 W450 (18")
50 (2") Front, 25 (1") Return

E. Black & Brass
36005 W400 (16")
36006 W450 (18")
50 (2") Front, 50 (2") Return

B. Satin Stainless Steel
36011 W400 (16")
36012 W450 (18")
50 (2") Front, 50 (2") Return



Club Fenders - Key: BB = Brass Backs fitted as standard. MES = Minimum extending size possible. Antique Brass & Satin Chrome finishes now available or any combination i.e. Black & Satin Chrome

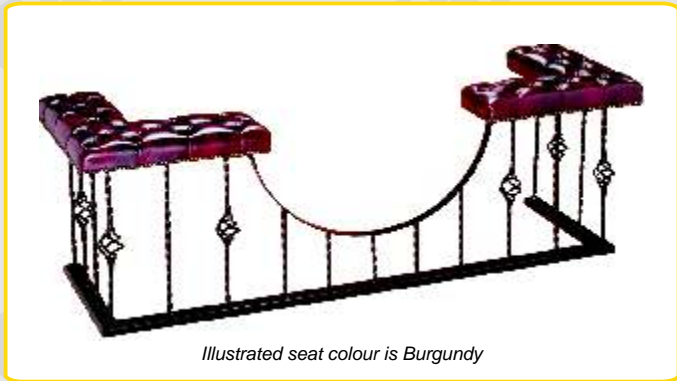

Illustrated seat colour is Burgundy

SPIRAL BLACK

Made to measure only, 4' (1220mm) minimum width.
3 row 'deep' buttons as standard.
Seat size shown approx W6.5"H20.5" (165x520mm)

Incorporating the finest quality hide with close attention to detail, the Club range offers the perfect solution for an exclusive fireside setting. With a range of seat covers including Burgundy, Antique Green, Burnt Copper, Earth Brown, Ocean Blue and Black. Seat styles can be varied to suit personal requirements with models illustrated depicting standard seat designs. For reasons of stability, we recommend a minimum base return of 12"(300mm). We will be pleased to provide a quotation for special sizes and configurations which can be manufactured to your requirements. Optional Brass Backs are available on all models, with the exception of the Regal Club and Spiral Black but are fitted as standard on the Canterbury.

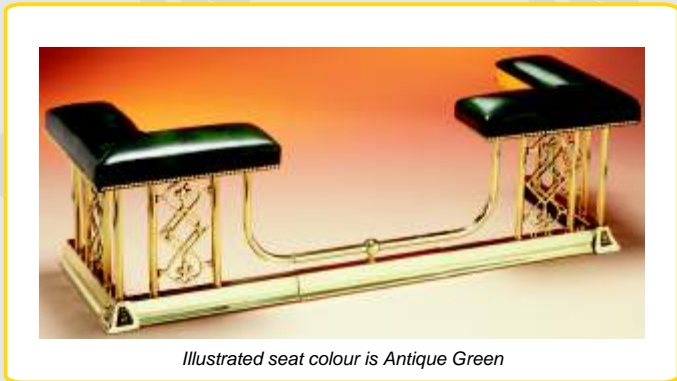

Illustrated seat colour is Antique Green

WINDERMERE

MES 4/5' (1220x1525mm). Unbuttoned as standard.
Seat size shown approx W6.5"H16.5" (165x254mm)

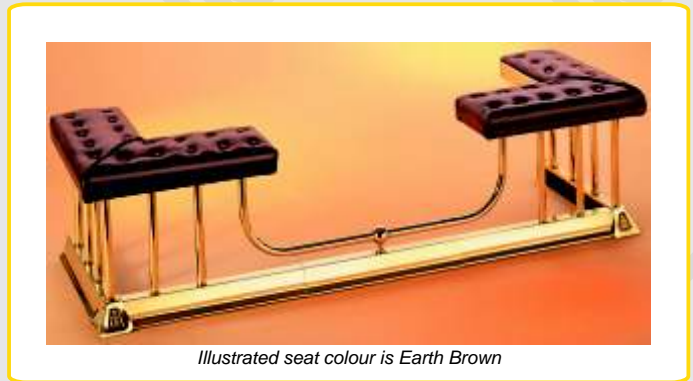

Illustrated seat colour is Earth Brown

MINI MAJESTIC

MES 4/5'. 2 row 'float' buttons as standard.
Seat size shown approx W6.5"H14" (165x254mm)

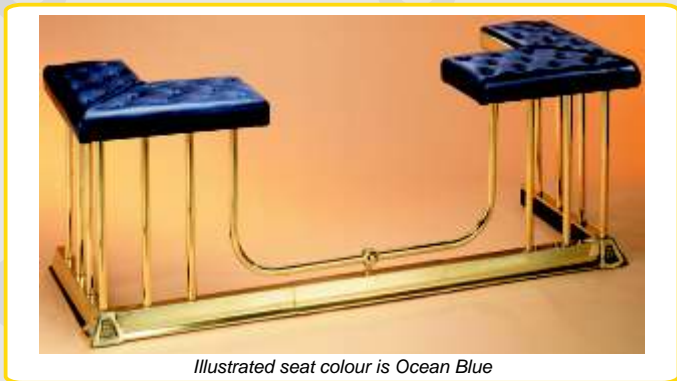

Illustrated seat colour is Ocean Blue

MAJESTIC

MES 4/5' (1220x1525mm). 3 row 'float' buttons as standard.
Seat size shown approx W7.75"H20" (195x510mm)

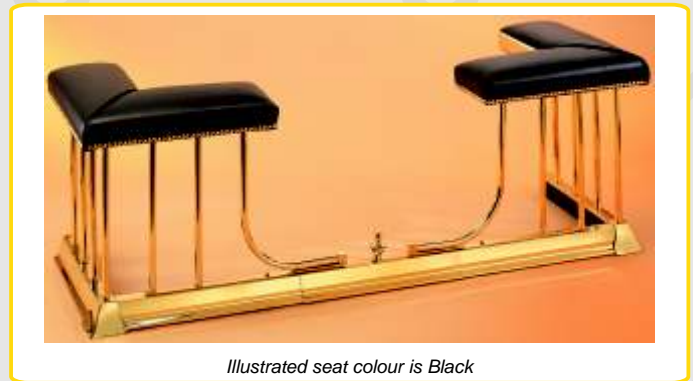

Illustrated seat colour is Black

REGENT

MES 4/5' (1220x1525mm). Unbuttoned as standard.
Seat size shown approx W6.5"H18" (165x460mm)

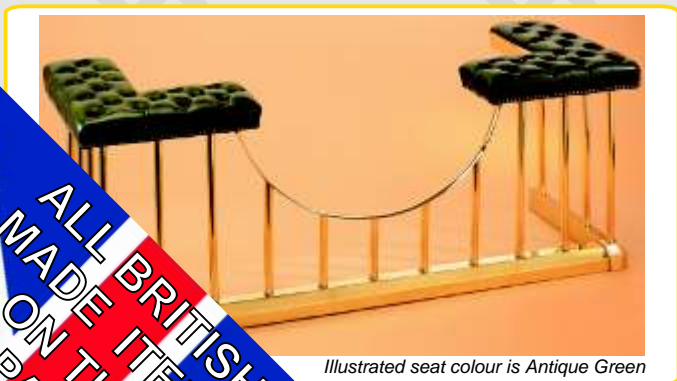

Illustrated seat colour is Antique Green

CANTERBURY MTM only,
4' (1220mm) minimum width.
3 row 'deep' buttons as standard.
BB Seat size shown approx
W6.5"H18"(165x460mm)



Illustrated seat colour is Burgundy

REGAL

Made to measure only, 5' (1525mm) minimum width.
3 row 'deep' buttons as standard. Seat size shown
approx W6.5"H20.5" (165x520mm)

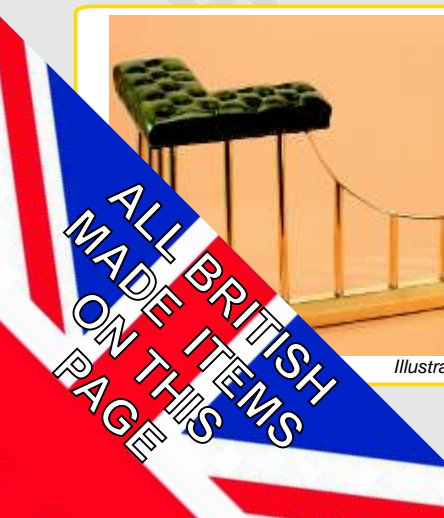



Hearth Fenders

All standard fenders have INTERNAL dimensions of 1220/1525 x 380mm (4'5"x15"), unless otherwise stated. We offer a bespoke service where width and depth dimensions as well as various finish options can be provided.



Sandringham Black & Brass
30025

Sandringham Brass
30015

Classic 6 Brass
30045

Classic 6 Black & Brass
30055

Classic 6 Black & Silver
30065

Classic 6 Silver
30075



Special Orders Fenders can include the Regal Base shown on Page 70.



Spiral Black & Brass
30275

Spiral Black & Silver
30285

Spiral Black
30265



Hearth Fenders - (4'5"x15"), unless otherwise stated. We offer a bespoke service where width and depth dimensions as well as various finish options can be provided.

Classic Base Brass
30035



Classic Base Black
30255



Classic Base Steel
30085



Special Orders Fenders can include the Regal Base shown below.

Regal Base Brass
30095

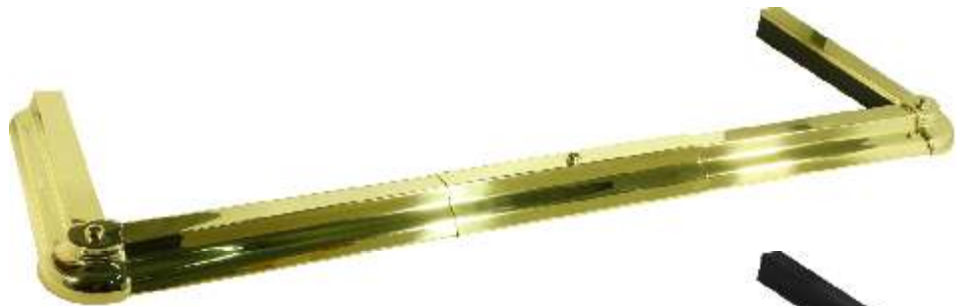

Regal Base Black
30115



Regal Base Steel
30105

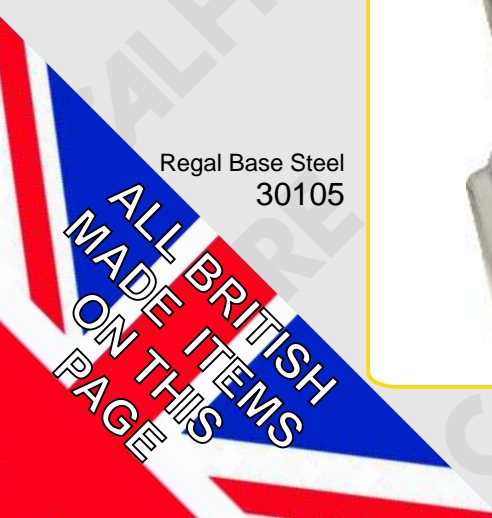

Hearth Fenders

Specified finishes relate to colour only and not material.

All standard fenders have INTERNAL dimensions of 1220/1525 x380mm (4/5'x15"), unless otherwise stated. The fenders offered on this page are only available in standard sizes and finishes.



Plain Base - 3 Piece



All Black
31006

6 Ball - 3 piece



Black & Brass
31003

Spiral Twist - 3 piece



All Black
31004

Black & Satin Nickel
31007



6 Urn - 3 piece



All Black
31000



All Black
31002

The Caframo Ecofan[®] is a heat-powered fan designed to circulate the warm air created by a wood or gas stove. Improved warm air circulation results in greater comfort and less fuel consumption.

Benefits of all Ecofans:

- * Increases Your Comfort**
- * Costs Nothing to Operate**
- * Cuts Your Fuel Costs**
- * Safe & Silent**

Choose an UltraAir 810 or an AirMax 812 for a wood-stove or the BelAir 806 for the lower stovetop temperatures found on many Gas; Pellet or Contemporary stoves.



812 AirMax
with Black
Blade shown.



It is important to read and follow the instructions on the correct placement of the Ecofan[®] to ensure satisfactory long term use.

We recommend the use of our Stovetop Thermometer 14077; see page 84 for details.

Full product details including technical, warranty and refurbishing service visit our product specific website at www.ecofan.co.uk

See page 75 for available spare parts.

Increased Efficiency

Warm air is pushed out into the living area rather than just rising to the ceiling above the stove. This improves the heating effectiveness of the stove and results in greater room comfort as shown below.

Heat distribution without an Ecofan[®]

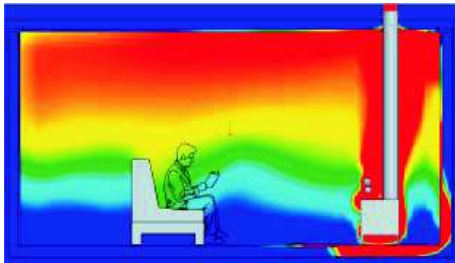

Heat distribution with an Ecofan[®]

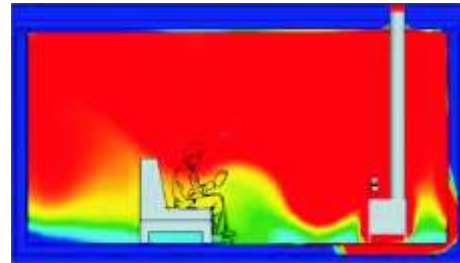

Fuel Savings

Tests carried out in collaboration with a leading Canadian university has proved that using an Ecofan[®] results in fuel savings of up to 18%. For more information please visit our website at www.ecofan.co.uk

'No Fuss' Operation

The Ecofan[®] starts automatically and adjusts its speed with the stove temperature. As the stove heats up, the Ecofan[®] runs faster to move more warm air into the room. As the stove burns down and cools, the Ecofan[®] automatically shuts off.

Costs Nothing to Operate

Using the heat from the stove, the Ecofan[®] is the most economical way to effectively circulate warm air. No cables, plugs or batteries are required.

Unique Blade Design - Safe and Efficient

The unique Ecofan[®] blade is designed to deliver a broad cross section of gentle warm air movement to avoid uncomfortable drafts. The blade is our most efficient blade yet, moving more air at a wider range of stove temperatures. Complies with IEC 60335-2-80 safety standards.

For Optimum Performance of your Ecofan[®]

Placement of your Ecofan[®] on your stove top is critical. Be sure to position the Ecofan[®] on the stove so that cool air will be drawn over the 'cooling fins'. The Ecofan[®] should not be used directly in front of the stovepipe or at the front of the stove. Place the Ecofan[®] at the back edge of the stove as shown in the diagram. See the enclosed user manual for further tips on positioning the Ecofan[®] on your stove.



Make the Right Choice of Wood-Stove Ecofan[®]

	ULTRAIR	AIRMAX
Model	810	812
Airflow	125 CFM*	175 CFM*
Fuel Savings	14%	18%
Feel the Heat Faster**	31%	38%
Minimum Stove Top***	100°C	85°C
Maximum Stove Top	345°C	345°C
Product Dimensions	222mm x 141mm x 93mm (8.8" x 5.6" x 3.7")	248mm x 153mm x 100mm (9.8" x 6.0" x 3.9")
Product Weight	0.76Kg	1.22Kg
Blade Size	206mm (8")	232mm (9")
Warranty	2 Year	2 Year

*CFM = Cubic Feet (of Air) per Minute

**Time taken to reach 20°C from a cold start of 17°C in a standard test environment.

UltraAir: 76 minutes AirMax: 68 minutes No fan: 110 minutes

*** Temperature required to produce 50 CFM airflow.



UltrAir 810 Wood-Stove Ecofan[®]

The Caframo UltrAir Ecofan[®] 810 is a heat-powered fan designed to circulate the warm air created by a wood-stove operating with surface temperatures of between 100°C and 345°C. The Ultrair 810 Ecofan[®] generates up to 125 Cubic Feet (of Air) per Minute. (At 100°C the UltrAir Ecofan[®] 810 will move 50 CFM)

Dimensions: Base Plate W121 D76 (4.75x3"). H222 (8.75") from base to top of casting, excluding handle. Blade diameter 206mm (8")



Ecofan[®]

The UltrAir 810 replaced the Original 800 Ecofan[®] in 2012.

The new unit moves considerably more air than its predecessor across all temperature ranges.

Which unit do you need? See page 73 for a list of benefits of the 810 and 812.

UltrAir 810 Ecofan[®]
E810BG
Black & Gold

UltrAir 810 Ecofan[®]
E810BN
Black & Nickel

UltrAir 810 Ecofan[®]
E810BB
All Black

It is important to read and follow the instructions on the correct placement of the Ecofan[®] to ensure satisfactory long term use and that your stove is working within the temperature range of 'best operation'. We recommend the use of our Stovetop Thermometer 14077; see page 84 for details.

AirMax 812 Wood-Stove Ecofan[®]

The Caframo AirMax Ecofan[®] 812 is a heat-powered fan designed to circulate the warm air created by a wood-stove operating with normal surface temperatures of between 85°C and 345°C. The AirMax Ecofan[®] 812 generates up to 175 Cubic Feet (of Air) per Minute. (At 85°C the AirMax Ecofan[®] 812 will move 50 CFM)

Dims: Base Plate W121 D82 (4.75x3.25"). H248 (9.75") from base to top of blade, excluding handle. Blade diameter 232mm (9")

Ecofan[®]

The AirMax 812 replaced the AirPlus Ecofan[®] in 2011.

The new unit moves considerably more air than its predecessor across all temperature ranges.

Which unit do you need? See page 73 for a list of benefits of the 810 and 812.



AirMax 812 Ecofan[®]
E812BB
All Black

74

AirMax 812 Ecofan[®]
E812BN
Black & Nickel

AirMax 812 Ecofan[®]
E812BG
Black & Gold

BelAir 806 GA Low Temperature Stove Ecofan[®]

The Caframo BelAir Ecofan[®] 806 GA is a heat-powered fan designed to circulate the warm air created by low temperature stoves operating with normal surface temperatures of between 75°C and 200°C. The BelAir Ecofan[®] generates up to 140 Cubic Feet (of Air) per Minute. (At 75°C it will move 50 CFM). The BelAir Ecofan[®] must not be used on a wood-stove or where the surface temperature exceeds 200°C.

Dims: Base Plate W162 D61 (6.4x2.4"). H241 (9.5") from base to top of blade. Blade diameter 232mm (9")



BelAir Ecofan[®]

The BelAir 806GA replaced the 806GS Ecofan[®] in 2013.

The new unit moves considerably more air than its predecessor across all temperature ranges.

We recommend the use of our Stovetop Thermometer 14077; see page 84 for details.

Type 806 GA Ecofan[®]
E806BG
Black & Gold

Type 806 GA Ecofan[®]
E806BN
Black & Nickel

Type 806 GA Ecofan[®]
E806BB
All Black

Spare Parts for Ecofans[®]

Replacement Motor and Blade Kits are available for the Ecofans as detailed below. Unfortunately we are unable to offer for sale thermo-electric modules as their replacement is a controlled process involving strict torque settings. If you believe the module has failed you are welcome to send your unit to CALFIRE who will quote you accordingly. Please note that we will only sell Ecofan[®] spare parts for use on original Ecofans[®]; not for any other purpose.

Motor Replacement Kits

After much usage an Ecofan[®] motor can wear out. Motor Replacement Kits are available for customers who wish to install a new motor rather than sending the old unit back to CALFIRE for repair, or purchasing a new Ecofan[®]. The replacement task is straight forward; however on some older models the consumer must have the capability to solder the new motor to the existing wires. The replacement kit comprises a new motor, an Allen/hex key to remove the blade and full instructions.



- ES001 800 Original, 802 AirPlus or 806GS (Soldering Type)
- ES006 800 Original, 802 AirPlus or 806GS (Push-On Type)
- ES009 810 UltraAir, 812 AirMax or 806GA BelAir (Push-On Type Only)

Blade Replacement Kits

Replacement blade kits comprise of; a new blade, a motor shaft securing grub screw, an allen/hex key to remove and refit the blade and full instructions. Please note that you cannot interchange blades between model types as they have different dimensions and rotate in different directions..



- 800 Original
- ES003 - Nickel
- ES002 - Gold
- 810 UltraAir
- ES012 - Nickel
- ES011 - Gold
- ES013 - Black
- 802 AirPlus or 806GS
- ES005 - Nickel
- ES004 - Gold
- 812 AirMax or 806GA BelAir
- ES008 - Nickel
- ES007 - Gold
- ES010 - Black



Stove Bright™ Paint



Colour Charts are available on request

Stove Bright™ High Temperature Paint

Stove Bright High Temperature Paint is a high quality, fast drying, high temperature paint for use on wood stoves, pipes, boilers, furnaces, flue pipes, ovens, engines, manifolds, barbecues and cast iron chimineas etc.

It can be used on any steel product with extreme surface temperatures up to 650°C and is ideal for touching up ceramic coals.

Unique in offering 3 'blacks' and a range of over 30 colours, Stove Bright is used by many of the leading stove manufacturers as their factory finish.

HTP AEROSOL CODES:

- 04001 FLAT BLACK
- 04002 SATIN BLACK
- 04003 CHARCOAL
- 04004 METALLIC BLACK
- 04005 METALLIC BROWN
- 04006 GOLDENFIRE BROWN
- 04007 HONEY-GLO BROWN
- 04008 METALLIC MOSS GREEN
- 04009 FORREST GREEN
- 04010 REDWOOD
- 04011 ALMOND
- 04012 METALLIC BLUE
- 04013 METALLIC GREY
- 04014 MAUVE
- 04015 GOLD
- 04016 RUSSET
- 04017 SAND
- 04018 MOJAVE RED
- 04019 SKY BLUE
- 04020 SILVER (ALUMINIUM)
- 04021 METALLIC MAHOGANY
- 04022 BROWN BARK
- 04023 PATRIOT BLUE
- 04024 METALLIC RICH BROWN
- 04025 METALLIC RED PRIMER
- 04026 MED TEMP CLEAR
- 04027 COPPER
- 04028 GREEN ILLUSION
- 04029 TERRA COTTA
- 04030 SHIMMERING ROSE
- 04031 SUNSET
- 04032 SURF SAND
- 04033 PEWTER
- 04034 EMERALD GREEN
- 04036 ADOBE TAN

HTP 236ml (½ US Pint)

TOUCH-UP CODES:

- 05101 FLAT BLACK
- 05102 SATIN BLACK
- 05103 METALLIC BLACK

Stove Bright™

Gas Vent Pipe Paint



Firmly snaps onto aerosol to provide greater and more comfortable spray control

AEROSOL CAN GUN
04051

Stove Bright Gas Vent Pipe Paint can be used on Double Wall Flue Pipe to match Vitreous Enamel Finishes. This is a high gloss coating capable of withstanding surface temperatures to 120°C. It is fast drying and easy to apply.

GAS VENT PIPE PAINT AEROSOL CODES:

- 04101 BLACK EBONY
- 04102 ALMOND
- 04103 SAND
- 04104 LIGHT BROWN
- 04105 BLUE
- 04106 GREEN
- 04107 HUNTER GREEN
- 04108 LIGHT RED
- 04109 DARK RED
- 04110 DARK BLUE



Stove Glass & Mica
season 2013/2014

Stove Glass Panels, Strips & Mica



CALFIRE STOCK SIZES FOR ALL POPULAR STOVE MANUFACTURERS

Panels

Calfire Panels are manufactured from the finest quality zero thermal expansion rated ceramic glass. Sizes are available from stock for all leading stoves and our in-house cutting facility means any size and shape can be quickly supplied to order.

Strips

Replacement Strips are supplied from the highest quality flat borofloat sheet. Calfire have Strips to suit the majority of stoves on the market and can supply specials with a rapid response guaranteed.

Mica

Ready cut stove panels and standard sheets are available

See price list for details



WE CAN CUT SPECIAL SIZES & SHAPES OF GLASS PANELS INCLUDING STRIPS AND MICA

WE RECOMMEND WHEN REPLACING A NEW GLASS PANEL TO ALSO REPLACE THE THERMAL ROPE SEAL.

PLEASE REFER TO PAGE 78-79.



FOR CLEANING AND RESTORING YOUR GLASS PLEASE REFER TO PAGES 85 -86.

Glass panels, glass strips and mica are supplied skin packed to display on euro-hooks. All size information provided in good faith, please ensure correct requirements are specified.

Please contact us for prices on any special sizes.



Stove Glass Rope
season 2013/2014

Panel Replacement Accessories

*Calfire thermal rope seal is fitted to stove and oven doors to provide an air tight seal.
Secure with Calfire Super Seal.*

WHITE THERMAL ROPE SEAL

Supplied in 2 or 25 metre rolls and thicknesses range from 3mm to 25mm.



SOFT BLACK THERMAL ROPE SEAL

Supplied in 2 or 25 metre rolls and thicknesses range from 6mm to 12mm.



BLACK THERMAL ROPE SEAL

Supplied in 2 or 25 metre rolls and thicknesses range from 6mm to 12mm.



	3mm	6mm	8mm	10mm	12mm	15mm	18mm	25mm
White 2M Pack	10002	10006	10010	10014	10018	10022	10026	10030
White 10M Pack	N/A	N/A	N/A	N/A	N/A	N/A	N/A	10032
White 25M Pack	10004	10008	10012	10016	10020	10024	10028	10033
Black 2M Pack	N/A	10035	10039	10043	10047	N/A	N/A	N/A
Black 25M Reel	N/A	10037	10041	10045	10049	N/A	N/A	N/A
Black Soft 2M Pack	N/A	10050	10052	10054	10056	N/A	N/A	N/A
Black Soft 25M Reel	N/A	10051	10053	10055	10057	N/A	N/A	N/A

A high temperature adhesive that withstands very high temperatures and is used to secure thermal rope/tape and ceramic fibre seal



CALFIRE SUPERSEAL

- 13001 30ml
- 13002 100ml
- 13003 500ml

Tape which prevents thermal rope ends fraying.



Thermal Rope End Sealing Tape

- 10601 White
- 10602 Black
- 25mm x 10M Roll

Panel Replacement Accessories

*Calfire thermal rope seal is fitted to stove and oven doors to provide an air tight seal.
Secure with Calfire Super Seal.*



WHITE THERMAL TAPE

Calfire thermal tape has many uses on a wide range of heating appliances. Secure with Calfire Superseal.

10510 - 40mm x 2mm x 2 metres

10512 - 40mm x 2mm x 25 metres



WHITE THERMAL LADDER TAPE

Calfire ladder tape is used for protecting the edges of glass panels.

10562 - 25mm x 3mm x 2 metres

10564 - 25mm x 3mm x 25 metres



CERAMIC FIBRE SEAL

This is used on many stoves to provide an air tight seal to the stove glass panels. Secure with Calfire SuperSeal.

14028 - 6mm x 4mm x 10 metres

14031 - 10mm x 4mm x 10 metres



WHITE ADHESIVE THERMAL TAPE

Calfire thermal tape has many uses on a wide range of heating appliances and is self adhesive.

10518 - 15mm x 2mm x 2 metre reel

10520 - 15mm x 2mm x 25 metre reel

10526 - 25mm x 2mm x 2 metre reel

10528 - 25mm x 2mm x 25 metre reel



BLACK ADHESIVE THERMAL TAPE

Calfire thermal tape has many uses on a wide range of heating appliances and is self adhesive.

10542 - 10mm x 2mm x 2 metre reel

10544 - 10mm x 2mm x 25 metre reel

10546 - 15mm x 2mm x 2 metre reel

10548 - 15mm x 2mm x 25 metre reel



Calcowl Anti-Downdraught Cowl



CALCOWL ANTI-DOWNDRAFT COWL 14025

Calcowl has solved many of the problems caused by downdraft, thus helping to provide a cleaner fresher environment within the home. It is suitable for all types of fireplaces; oil, gas and solid fuel boiler systems.

Calcowl ensures a more evenly controlled draw that can lead to improved fuel consumption. Use of the Calcowl reduces the risk of fire by greatly reducing the build up of tarry soot inside the flue system. The product is manufactured using top quality acid resistant stainless steel, is maintenance free, easy to fit, silent, effective and fits most chimneys with a maximum external diameter of 255mm (10").

Mini EuroCowl Static Anti-Downdraught Cowl

Designed to cure smoky fireplaces. Prevents down-draughts by creating a positive airflow whatever the wind direction. Fits flue sizes 125mm to 250mm internal diameter. Also prevents birds, vermin and rain entry. Suitable for all fuels, remove bird guard when used with solid fuel to prevent clogging. Supplied fully assembled and ready to fit.

Maintenance: High dome allows for effective sweeping in situ.

Approvals: BS/EN 1856-1 2009

Accessories: 316 grade Adaptor Plate to allow fitting to flexible flue liner or rigid liner/free standing metal flue; Can also be fitted direct to the Euro Pot Hanger (125 and 150mm) and the Euro Twinwall adaptor (150mm). See Price List for details.

The Aluminium Mini EuroCowl is supplied with a mesh birdguard and is suitable for all locations using gas, oil or coal.

The Stainless Steel version does not include the mesh birdguard. It is suitable for all locations using all fuel types including coal & smokeless coal. If required a stainless steel mesh birdguard can be ordered as a separate item; see Price List for details.



Mini EuroCowl Terracotta

14083 Aluminium
14087 Stainless Steel

Mini EuroCowl Natural

14085 Aluminium
14089 Stainless Steel

Mini EuroCowl Black

14086 Aluminium
14090 Stainless Steel

See price List for available Accessories

Euro Topguard Bird/Rain Guard

Designed to prevent birds, vermin and leaves entering chimney flues whilst maintaining flue efficiency. Provides good ventilation and added protection against wind and rain entry.

Accessories: This model can be used in conjunction with Pot Hangers, Twinwall Adaptor or the Adaptor Plate. See Price List.

Maintenance: The high dome allows for effective sweeping without the need to remove the cowl from the chimney pot.

Sizes: Fits pots from 125mm (5") to 250mm (10")

Approvals: BS5871 (terminals up to 250mm (10").

The Mild Steel (zinc primed and powder coated) Topguard is suitable for inland locations using gas, oil or coal.

The Stainless Steel version is suitable for both inland and coastal locations using all fuel types including coal & smokeless coal.



Mild Steel Euro Topguard

14091 Terracotta

14092 Cotswold Stone (as shown)

14093 Black

Stainless Steel Euro Topguard

14094 Terracotta

14096 Black

14097 Natural

See price List for available Accessories

Euro Topguard 2 Bird/Rain Guard

The Euro Topguard 2 has all the benefits of the original Euro Topguard but incorporates a new alternative method of fixing using Stainless Steel banding and pre-assembled support straps.

The Mild Steel (zinc primed and powder coated) Topguard is suitable for inland locations using gas, oil or coal.

The Stainless Steel version is suitable for both inland and coastal locations using all fuel types including coal & smokeless coal.



Mild Steel Euro Topguard 2

14098 Terracotta (as shown)

14100 Black

Stainless Steel Euro Topguard 2

14101 Terracotta

14103 Black

14104 Natural

CALFIRE

Fire Cements
season 2013/2014

Fire Cements & Compounds



PROFESSIONAL
SEALANT GUN
14079 C3



Mouldable Firebrick

For quick and economical repairs or replacements for firebricks in any heating appliance, stove, open fire, wood burner etc. Tested to 1600°C

12021 5Kg.



Flue Jointing Compound

Ready-mixed non setting compound accommodates slight movement in joints without cracking. Not suitable for use within 1 metre of solid fuel appliances.

12012 500g



Heat Resistant Tile Adhesive

Ready-mixed adhesive for fixing tiles in areas subject to high temperatures, such as fire surrounds, behind boilers, cookers and radiators. Resistant to 1000°C.

12023 300ml CARTRIDGE



Premium Fire Cement

A range of premium ready mixed fire cement. Ideal for patching and repairs to firebricks, fireplaces, solid fuel ovens, boilers and central heating systems. Tested to 1250°C

BUFF: 12001 500g
BLACK: 12008 12009
12002 1Kg
12003 2Kg
12010 12025 5Kg
12026

BLACK CARTRIDGE
12007 300ml



C H System Inhibitor

Central Heating System Inhibitor is a multi-purpose treatment, specially designed to protect the entire central heating system from scale, sludge and corrosion.

13026 1L



CALFIRE The Fireside Collection



Heat Resistant Sealant

A ready mixed high temperature sealing and caulking paste for use in fixing and jointing as well as for fire protection will withstand up to 1250°C.

BEIGE:
12027 300ml Cartridge



Heat Resistant Silicone

Providing excellent adhesion to most building materials this product is specifically designed and recommended for high temperature applications up to 300°C.

BLACK:
12024 310ml Cartridge

Gas Fire Spares - Ceramics



New Pack
Size



GAS EMBER PACK
14113 250g



COALS
SMALL
14043 (BAG15)
14041 SINGLE



COALS
LARGE
14044 (BAG10)
14042 SINGLE

Service & Installation Products



HEAT RESISTANT GLOVES
14080

Red Lined Gauntlet. Category 2 - Intermediate design.
Manufactured to EN388 & EN407



CORE DRILL
'BLACK HOLE' WALL VENT
14112

Terracotta External Cowl, 127mm (5") Diameter.
350mm (14") Tube Length

Free Area cm² - 70cm² (With Baffle) 100cm² (Without Baffle). Rated Output - 21kw Max



FLUE BRUSHES:

- 14008 L3'Dia.2"(915x50mm) GUMATI
- 14010 L3'Dia.4"(915x100mm) GUMATI
- 14011 L4'Dia.4"(1220x100mm) GUMATI
- 14012 L5'Dia.4"(1525x100mm) GUMATI
- 14114 L5'Dia.5"(1525x127mm) NYLON*
- 14115 L6'Dia.6"(1830x152mm) NYLON*



*2 New Size options



CO DETECTOR
14070 SINGLE PACK



SMOKE MATCHES
14001 CLASSIC
(BOX12)

SMOKE PELLETS
14002 13g (TUBE5) 14061 5g (TUBE5)
14064 13g (TUBE50) 14062 5g (TUBE50)
14065 13g (TUBE100) 14063 5g (TUBE100)

See price list for full details

Carbon Monoxide Alarm



This compact but feature-rich CO alarm has been independently certified to EN50291:2001, providing total peace of mind for the installer and the householder.

The COA1 CO Alarm can be wall or ceiling mounted and is supplied with a sturdy mounting plate, screws and fixings, allowing the Installer to meet the requirements of Building Regulations Approved Document J (A.D.J.:2010)

The SleepSafe COA1 Carbon Monoxide Alarm has a loud 85dB siren, a Test / Reset Button and a Sensor end-of-life warning.

The COA1 is covered by a conditional 6 year guarantee.

**SLEEPSAFE COA1 CARBON
MONOXIDE ALARM
14082**

Stove Thermometers



Ensure your stove is operating at the correct temperature by using this magnetic thermometer that attaches to your stove pipe. If your stove is too cold then creosote deposits will form, if its too hot then you are wasting both energy and money.

The CALFIRE Stovepipe Thermometer is NOT designed or calibrated for the hotter surfaces of your stovetop.

**CALFIRE
MAGNETIC STOVEPIPE
THERMOMETER
14024
Dia.63 (2.5")**



Ensure your stove is operating at the correct temperature by using this magnetic thermometer that sits on your stovetop. If your stove is too cold then creosote deposits will form, if its too hot then you are wasting both energy and money. The white area shows the optimal stove operating temperature.

This unit is not calibrated for use on your Stovepipe.

**MAGNETIC
STOVETOP
THERMOMETER
14077
Dia.63 (2.5")**

Karcher Ash Filter

Ash Filter

Consisting of 20L container, 1M flexible metal suction hose and 1M metal suction tube (230 mm).



**KARCHER ASH FILTER
14081**

When connected to a vacuum cleaner the Karcher Ash Filter provides trouble-free cleaning of fireplaces, wood-burning stoves, barbecues & sauna ovens. Also suitable for picking up coarse dirt and debris, e.g. sand or sawdust. Suitable for use with most domestic vacuum cleaners, however you must use a wet & dry machine if you want to pick up wet leaves etc...

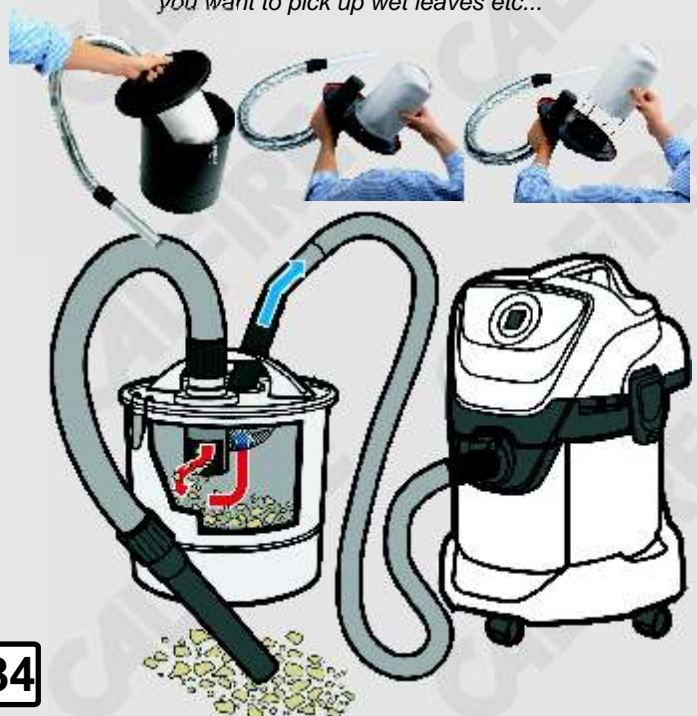

Cleaning & Restoration Products



A blend of detergents and solvents in a foaming aerosol formula, which removes grease and dirt from all types of surfaces with its amazing cleaning power.

PEEK SPRAY-AWAY
13603
400ml aerosol

Peek



Developed for professionals and demanded by those who have tried it, Peek is a 4-in-1 cleaner that cleans, polishes, restores and protects 38 surfaces including brass, copper, stainless steel, silver, gold, chrome, fibreglass, ceramics, glass, acrylics and painted surfaces. When The Royal Yacht Britannia was in service everything on board, from the Royal George Binnacle to each piece of silver, was kept in pristine condition by the Yachtsmen using Peek Polish. This resulted in the products manufacturer being awarded the Royal Warrant in 2005.

PEEK LIQUID POLISH
13604
250ml tin



PEEK CREAM POLISH
13601 250ml tin



PEEK CREAM POLISH
13600
100ml tube

SCHOTT ROBAX®



A dry glass cleaner specifically developed by Schott Robax® for cleaning glass ceramic panels.

DRY WIPER
13605

CALFIRE



Removes stains from Stone, Brick and Concrete.

FIREPLACE CLEANER
13012 500ml



Seals and protects slate, enhancing its natural beauty, repelling dirt and water whilst allowing the slate to breathe.

SLATE SHEEN
13017 500ml



Removes the toughest tar, soot and creosote stains from stove window glass.

SPRAY ON STOVE
GLASS CLEANER
13011 500ml



Removes the toughest tar, soot and creosote stains from stove window glass.

STOVE GLASS
CLEANER
13009 500ml



Removes the toughest burnt on stains from vitreous enamelled surfaces.

VITREOUS ENAMEL
CLEANER
13007 500ml

Cleaning & Restoration Products



A water based graphite polish suitable for wood/coal stoves, grates and surrounds.

BLACK STOVE & GRATE POLISH
13504 170g



A very effective polish for use on copper, brass, nickel, pewter, chrome and gold. Multi-use metal polish gives a cleaner, more protective, longer lasting shine.

MULTI-USE METAL POLISH
13512 150ml tube



A water based graphite polish suitable for wood/coal stoves, grates and surrounds.

BLACK STOVE & GRATE POLISH
13503 75ml tube



Flue Free helps to maintain clean chimneys for maximum efficiency, lower fuel costs and a reduced risk of fire.

FLUE FREE CHIMNEY CLEANER
13500 750g



A foaming formula that will stick to vertical surfaces to dissolve smoke stains and tar/creosote deposits.

GLASS CLEANER
13506 320ml aerosol



Uses an oxygen based bleaching action to remove smoke, soot and tar stains from stone, concrete, marble and other hard surfaces.

FIREPLACE CLEANER
13510 500ml



A special formulation that makes the surface of natural brick and stone strongly repellent to oil, water dirt and dust.

BRICK & STONE SEALER
13511 500ml



Seals and protects slate, enhancing its natural beauty, repelling dirt and water whilst allowing the slate to breathe.

SLATE OIL
13515 100ml



Developed in Italy, this product is for polishing worn and dull marble surfaces. (non abrasive)

ITALIAN MARBLE POLISH
13513 200ml



An ultra high temperature paint specially formulated for applying a decorative finish to new, or for rejuvenating old, ceramic coals used in gas fires. Coal Paint is colour fast to 650°C.

COAL PAINT
13516 300ml

Meet the CALFIRE Team

Eric Allen
Group Managing
Director

Dave Barnes
Operations
Manager

Tony Janicki
Driver

Paul Adams
Group Financial
Director



Jamie Winter
Warehouse

Ieuan Jones
Warehouse
Supervisor

**Bronwen
Roberts**
Group Sales
Ledger

**Yvonne
Morris**
Sales Office

**Marie
Lomas**
Sales Office
Manager

**Lynne
Gollan**
Group Purchase
Ledger

John Williams
Warehouse

Keith Roberts
Sales Office

Barry Loynes
Director/General
Manager

Rob Learmonth
Business Development
Manager

Daryl McMaster
Sales Agent for
South East



Since joining the company in 2011 Rob has assisted the General Manager with all aspects of developing the business.



A name and face well known to many in the industry, Daryl brings a wealth of knowledge and experience to the company.

CALFIRE SPARELINE LIMITED

GLEDRID. CHIRK. WREXHAM. LL14 5DG. UK

EMAIL: sales@calfire.com

URLS: www.calfire.com
www.ecofan.co.uk

TEL: 01691 772922

FAX: 01691 773552

A member of the CALFIRE GROUP of companies